



WIPCOOL[®]
FEELING FOR MORE

www.klimapreteba.sk

WIPCOOL[®]
FEELING FOR MORE

STEAM A/C CLEANING MACHINE **C30S**

— OPERATION MANUAL —



High Temperature Steam
Strong Cleaning



1. Notice for Use

Thank you for buying WIPCOOL C Series A/C cleaning pump, we are dedicated to providing you with high quality products.

Please check if your ordered product is in good shipment condition, with the correct accessories, any damage during transportation, please contact us or the local distributors in time if you find any problems.

This manual gives instructions on the correct operation, it's important that you follow this instructions carefully.



If there is any change in the product (including the specification), we won't inform any more.



⚠ WARNING





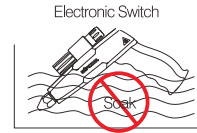

To ensure the product long-time stable working, please read this manual carefully before your installation, transportation, repair or maintenance, in order to fully understand the safety problems, the technical data and operating methods of the pump and other related notices points.

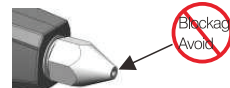
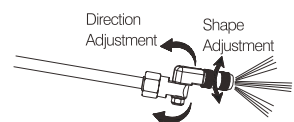
2. Caution

Note the following points during use

<p>① Make sure inlet hose is in the bucket, start the machine in "COOL" mode to avoid machine in dry running and get in dry burning protection. "STEAM" MODE must be used with clean water.</p> 	<p>② The maximum power of this machine is 3300W, please use it under the range of power supply, if the general domestic power line cannot bear and trip, please use small steam or 2200W "HOT" water function, do not use large steam and 3300W "HOT" water function, so as not to burn out the circuit.</p> 
---	--

<p>③ Strong acid detergent is not allowed. We are unable to accept any liability in case of blockage or breakage for nonconforming usage.</p> 	<p>④ Spray gun soaked in the water is not allowed, to avoid any internal parts damaged.</p>  <p>Electronic Switch</p>
<p>⑤ $\varnothing 2$mm short and long spray nozzles are just used on steam mode, 200°C spinning gun should be used in HOT and COOL mode. STEAM mode is not allowed.</p> 	<p>⑥ Do not touch directly by hand as the internal heater and steam nozzle temperature is very high after using steam and hot water function</p>  <p>Touch After Cooling</p>
<p>⑦ Please check if any blockage in Nozzle vent hole if poor steam, white dirt will be created after long time using.</p> 	<p>⑧ Direction can be adjusted by left or right turning, water shape (columnar or mist) can be adjusted by nozzle switching)</p> 

<p>⑨ It will take about 25s to create steam when you start "STEAM" MODE.it is normal when the water reserved in the pipeline automatically drained before the steam is out.</p>  <p>Steam nozzle only for "STEAM" mode</p>	<p>⑩ Please use "COOL" mode to drain out the inside water before you shut down this machine."STEAM" or "HOT" mode is forbidden.</p>  <p>Choose "COOL" mode to do drainage</p>
<p>⑪ "High Temp" warning will light on the LCD display and indicate over-temperature. Please check if the inlet filter's blockage caused the poor water suction or shortage. Clean the filter and Machine will resume working after 20minutes cooling.</p>  	<p>⑫ If the machine cannot do self-priming, please fulfill with water into pipe and pump until outlet overflows, then it will resume normal working.</p>  <p>Inlet Hose</p>
<p>⑬ Please stop working immediately once the machine gets wet, plug off. Dry off and let it dry naturally before you restart it.</p> 	<p>⑭ Don't spray to any people, pets and machine itself to avoid accident during operation.</p>  <p>Hightemp Danger</p>

⚠ Attention in "HOT" mode

- Corrosive detergents are not allowed. We are unable to accept any liability if it caused corrosion or damage.
- The "HOT" mode can be adjusted to 3options, high, medium and low water pressure, the temperature can be adjusted to 3options, High temp(3300W), Medium temp(2200W), and Low temp(1100W).
- You can adjust the water temperature and pressure according your different needs, the normal temperature water can be directly heated to 60 °C, and the circulating hot water can reach 100 °C to achieve better cleaning.
- Be sure to clean the internal line of the machine with clean water after each use.

⚠ Attention in "STEAM" mode

- Make sure inlet hose is in the bucket with clean water, start the machine with "COOL" mode firstly to avoid machine in dry running and get in dry-burning.
- Be sure used with clean water, detergent or dirty water is not allowed.
- Adult operate only
- Inlet water temperature should be no more than 50°C.
- Do not block the steam ejection vent during operation, to avoid the high inner pressure, and cause the serious damage.
- There will be a preheating procedure when start the "STEAM" mode, so Water spillage is normal.
- Clean inlet filter before use to avoid blockage.
- There will be 1second's cool water extension, be careful of high pressure and high temperature water during this extension.
- Please choose "COOL" mode to drain off the inside water after use. It will cause "HIGH TEMP" warning if choose "HOT" or "STEAM" for drainage.
- Machine will switch to "COOL" mode automatically if "High Temp" light on the LCD and enclosed with voice alarm, "STEAM" mode will resume working when the temperature is down.

2. Product Instruction

1. Product overview

WIPCOOL C serious A/C cleaning machine is special design for domestic Air Conditioner and small refrigeration equipment cleaning. Built-in permanent magnet motor powered water pump.the product features as below:

- High temperature and high-pressure steam, pure physical sterilization and disinfection
- Multiple stage water temperature to meet the requirements of different working conditions
- LCD touch display, voice reminder, more humanized operation
- Intelligent spray gun, one-touch operation during operation, convenient function selection
- Steam, hot water and cold-water flow in and out of the same pipeline, simple maintenance
- Super ozone sterilization, Prevent bacteria
- Drum pump body structure, freely retractable inlet and outlet pipes

2. Key operation instruction

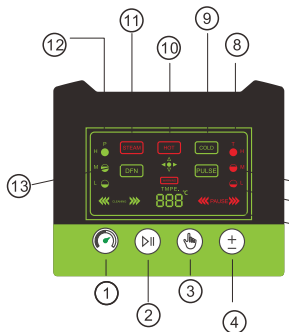

PLUG IN CORRECT POWER (Minimum 230V,16A) STOP USE 3300W "STEAM" AND 3300W "HOT" MODE IF TRIPPER	
Cleaning Mode Keys	9 COOL 3 modes of pressure can be adjusted in "COOL" mode
	10 HOT 3 modes of pressure can be adjusted in "HOT" mode
	11 STEAM 3 modes of temperature can be adjusted in "HOT" mode
	13 DISINFECT Ozone disinfection
	7 PULSE Pulse cleaning
Adjustment Keys	1 PRESSURE H-M-L pressure switched in "COOL" AND "HOT" MODE Big-Small steam switched in "STEAM" mode
	2 WORKING STATUS CLEANING/PAUSE
	3 FUNCTION Cleaning model switched.
	4 TEMP/MOISTURE STATUS H-M-L temp/moisture adjustment in "HOT"/"STEAM" MODE
Cleaning Mode Keys	5 TEMP Indicate the outlet water or steam's temperature
	6 "HIGH TEMP" WARNING "HIGH TEMP" warning, Over heat protection
	8 TEMPERATURE STATUS H-M-L temperature or moisture's indication
	12 PRESSURE STATUS "H-M-L Pressure" indications or "Big-Small steam"

⚠ Remark: The steam moisture can not be adjusted remotely by multi-functional spray gun, only by pressing "temperature / moisture" on the control panel.

Multi-function Spray Gun

The spray gun reached the multi-function of water pressure adjustment, cleaning mode switching, ON/STOP through remote action. Turn on light when in dark place.

2 different functions under CLEANING/PAUSE status.

A, when machine is in "PAUSE" status, press the "FUNCTION" key to choose your cleaning mode "COOL", "HOT", "STEAM", "DISINFECT", "PULSE"

B, when machine is on operation in "COOL", "HOT" mode, press the "FUNCTION" key to adjust water pressure.

C, when machine is on operation in "STEAM" mode, press the "FUNCTION" key to adjust steam pressure.



3. Application & Range

C Serious STEAM A/C cleaning machine is special design for indoor or outdoor units. But it is also can be used in household appliances such as lampblack machine, refrigerator, washing machine, water heater, water dispenser, etc.

The machine applied the instant high-temperature working principle. Realize the disassembly free cleaning for air conditioner and fume hood. Clean the harmful substances such as scale and rust in drinking water machine, water heater and other household appliances through circulation washing. It has super strong ozone sterilization technology, which can completely sterilize the areas where are easy to breed, such as drinking machine, washing machine, refrigerator and so on. the bactericidal rate is 99.9%.

4. Technical parameter

“COOL/HOT” MODE		“DISINFECT” MODE	
Voltage	AC230V~50-60Hz	Voltage	AC230V~50-60Hz
Power(HOT)	High:3300W Medium:2200W Low:1100W	Power	8W
Suction	1.5m	Air purification	51~150m ³ /h
Pressure	3~6bar	Bactericidal rate	99.9%
Flowrate	5L/min	Algaecidal rate	99.9%
Temp	85°C~100°C(circulation)	Ozone	300mg/h
Inlet	1.5m	Ambient temp	-10°C~+60°C
Outlet	3.5m	Outlet	2.5m
“STEAM” MODE		MEASUREMENT	
Voltage	AC230V~50-60Hz	L	380mm
Power	Big steam:3300W Small steam:2200W	W	290mm
Steam	120°C~150°C	H	290mm
Continuous working time	180min	Weight	5.5kg
Outlet	4.0m		

5. Measurement

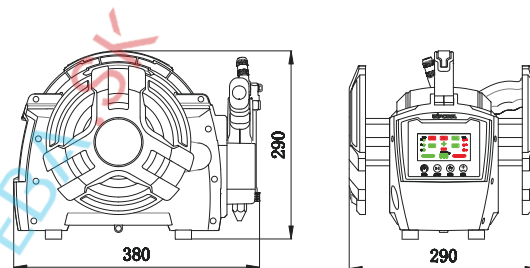

6. Product configuration

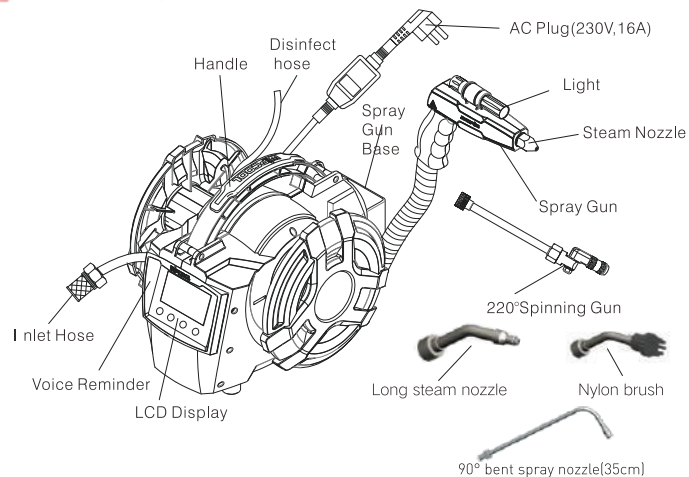

7. Operation procedure

7.1 Inspection before Operation

Please check any damage of products and accessories, any blockage of filter and nozzle, any abnormal for assemble or connection before your operation.

7.2 Correct usage

1. put the inlet pipe into the bucket with clean water inside.

As shown on the below picture.



Make sure inlet hose is in the bucket, start the machine in "COOL" mode to avoid machine in dry running and get in dry burning protection. "STEAM" MODE must be used with clean water.

2. Plug in correct AC power (230V/16A), then make the leakage testing. Start the operation after LCD display lights and Voice prompts
3. Put the spray nozzle towards the bucket, then select your cleaning function-mode (COOL, HOT, STEAM, DISINFECT, PULSE) through touching keys on LCD or Multi-function Spray Gun, adjust the pressure and temperature according your requirement.
4. 220° spinning gun should be just used in "HOT" and "COOL" mode. Direction can be adjusted by left or right turning, water shape (columnar or mist) can be adjusted by nozzle switching.
5. ϕ 2mm spray nozzle is just used on "STEAM" function only.
6. Please switch to "COOL" mode and last for 10 seconds after use "STEAM" or "HOT" mode, to cool down the inner heater quickly.
7. 140°C-150°C is in big "STEAM" mode, 130°C-140°C is in small "STEAM" mode.
8. Press "RESET" key on the PLUG for short-time shutdown.

8. Troubleshooting

Problem	Cause	Action
No lighting when plug in	Plug loose or switch plug "OFF".	Plug loose or switch plug "ON".
Stop working during operation	Circuit or Socket's overloading	Use the high-loading circuit or socket
Low pressure of nozzle	Air in the pipe	Disassemble the spray gun and fit again after the machine start working.
	Blockage in the filter	Clean the filter
	Dirt inside the nozzle	Clean the nozzle.
No water coming during the operation	Blockage inside the water pump	Fulfill with water into pipe and pump until outlet overflows, then it will resume normal working.
	Inlet filter blockage	Clean filter
No steam or big and small in sudden.	Inlet pipe are not in the water	Put the inlet pipe into water and start working with "COOL" mode
	Inlet filter blockage	Clean filter
	Overheat protection	Re-start after 20m shutdown cooling
	Dirt water	Use the clean water
Water Leakage	1. loose connection 2. sealing losing	1. fasten the connection 2. change sealing
Abnormal voice	1. Air inside in the machine 2. Inner spare parts damaged	1. check the water level or pipe's damage 2. disassemble and repair

⚠ Attention: if "high temp" warning occur frequently, please contact with manufacturer and solve the problem timely.