

 KLÍMA PRE TEBA .SK

 KPT.CZ

WPTC-24-01E



Product Selection Guide



 **YouTube**
Scan us for more details
www.wipcool.com



Table Of Contents

Condensate Management **P009-048**

Mini Pumps **P011-022**

Tank Pumps **P023-034**

Supermarket Pumps **P035-040**

Atomization Pump & Accessories **P041-048**

HVAC Maintenance **P049-090**

Coil Cleaning Machine
(Medium Pressure) **P051-058**

Coil Cleaning Machine
(High Pressure) **P059-066**

Steam Cleaning Machine
& Cleaning Cover **P067-072**

Electric Sprayer **P073-074**

Tube Cleaning Machine **P075-080**

Refrigeration Compressor
Oil Charging Pump **P081-090**

HVAC/R Tools & Equipments **P091-142**

Recovery Machine **P095-098**

Vacuum Pumps **P099-112**

Refrigeration Tools **P113-122**

Tubing Tools **P123-134**

HVAC/R Testing & Measuring Equipment **P135-142**

KLÍMA PRE TEBA .SK

About WIPCOOL

WIPCOOL was established in 2011 in Zhejiang, China. Since its establishment, WIPCOOL has been committed to providing one-stop solutions for installation, maintenance tools & equipment for technicians in the air conditioning and refrigeration industry, adhering to the mission of "Always adhere to creating differentiated and ideal HVAC products". Through continuous technological innovation and change, it promotes the overall development of the industry and saves resources for society.

Over more than ten years of continuous development and technological precipitation, WIPCOOL has been a leader in the condensate pumps in worldwide, and the company has gradually formed three major business units:

Condensate management, HVAC system maintenance, and HVAC/R tools and equipment, providing high-quality, innovative, and advanced products to global channel users.

WIPCOOL will adhere to the "IDEAL PRODUCTS FOR HVAC" focus strategy from a future perspective, establish comprehensive sales channels and service networks worldwide, and provide the best products and solutions for users in the global air conditioning and refrigeration industry.

Factory Scene

Condensate Management



HVAC Maintenance



HVAC/R Tools & Equipments



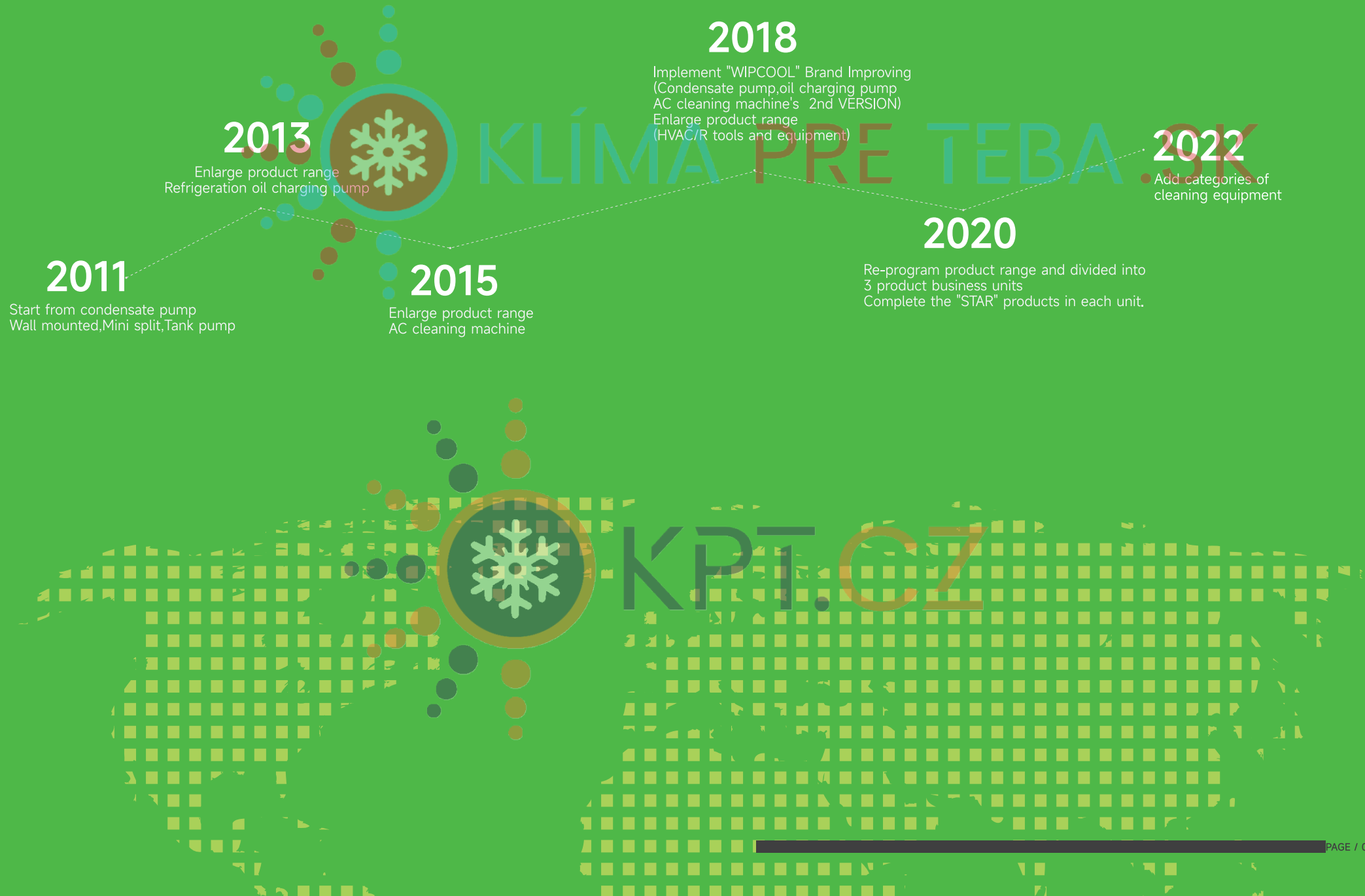

Company Culture

Vision / Becoming the preferred brand in the HVAC/R service industry

Mission / Always adhere to creating differentiated and ideal HVAC products

Values / Customer first, teamwork, integrity, dedication and passion

KLÍMA PRE TEBA .SK

WIPCOOL

KP CZ

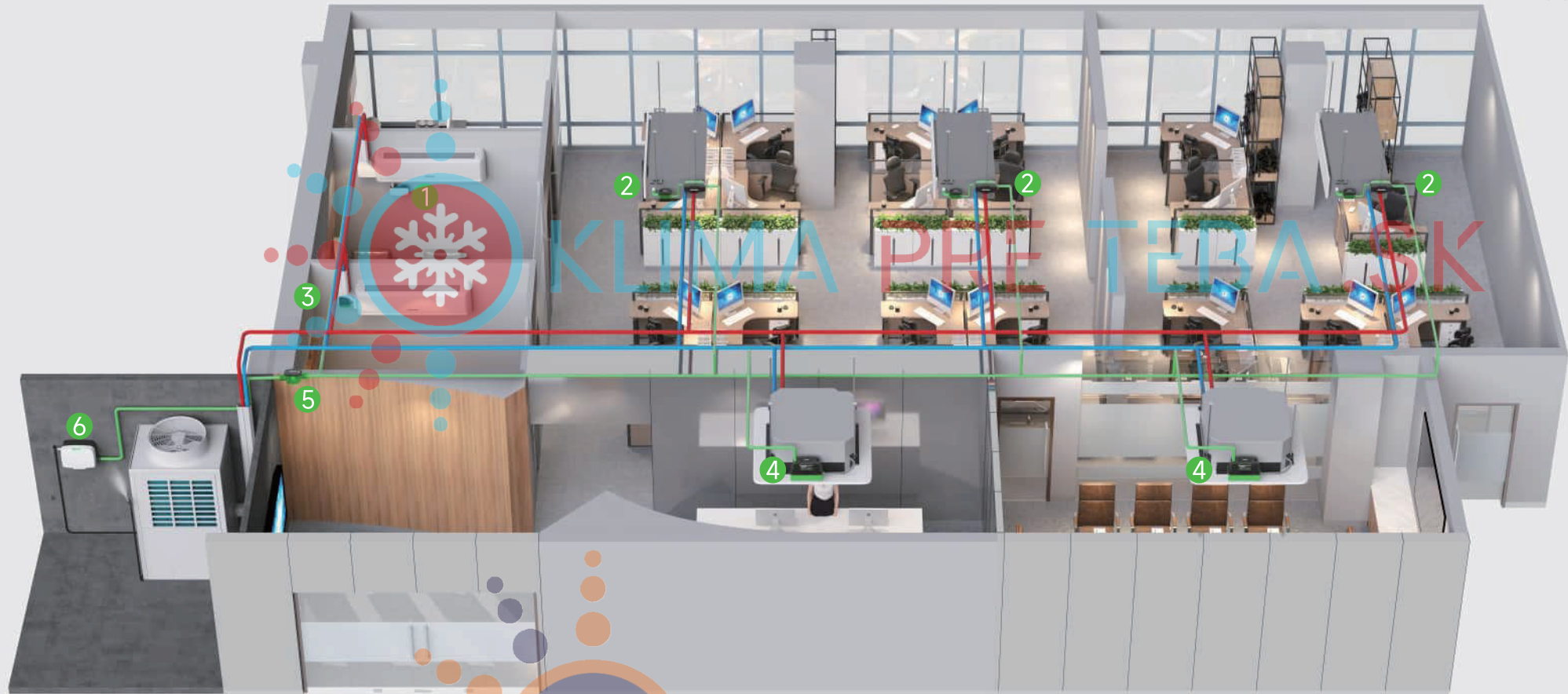

Condensate Management

The condensate pumps is the earliest business segment involved by WIPCOOL and also one of the most well-known products in the market. Specially designed to solve the problem of your air conditioning and refrigeration equipment being unable to discharge condensate water through gravity, the product covers mini pumps in various installation positions, tank pumps of different lifts and flow rates, and supermarket pumps match different sizes of refrigerated cabinets. Whether it is household, commercial, or industrial equipment, WIPCOOL can provide a complete set of products that solve condensate discharge.

With the continuous in-depth research on the condensation discharge of air conditioners & refrigeration equipments by WIPCOOL, products such as floating-ball condensate trap installed on the condensate water pipes, external liquid level controllers with drainage pump safety switches, and atomization pumps that utilize condensate waste to improve the heat exchange efficiency of refrigeration equipments have been gradually developed.

Application Introduction

- 1 Wall-mounted Condensate Pump
- 2 Mini-split Condensate Pump
- 3 Corner Condensate Pump
- 4 Tank Pump
- 5 Condensate Trap
- 6 Condensate Atomization Pump

Mini Pump Series

WIPCOOL offer the most complete and high performance range of mini pumps in worldwide. Widely applied for split, ducted-type and cassette-type air conditioning units, as well as other appliances that produce small amounts of condensate.

Some items equipped by brush-less motor, safety switch, probe sensor which maintain pump's high performance, ensure the pumps operate silent, durable with long service life.



Why Choose WIPCOOL Mini Pumps?

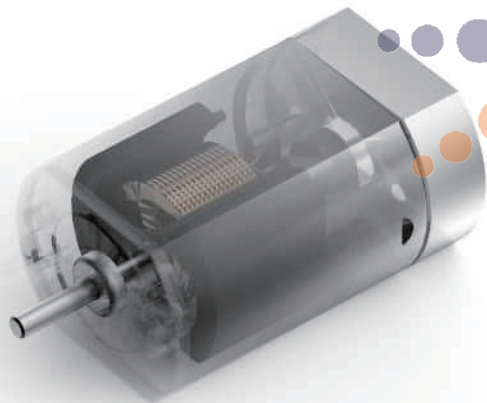

- Compact & powerful
- Quiet & reliable
- Innovation driven
- Easy Maintenance

Discharge Pipe Run Performance

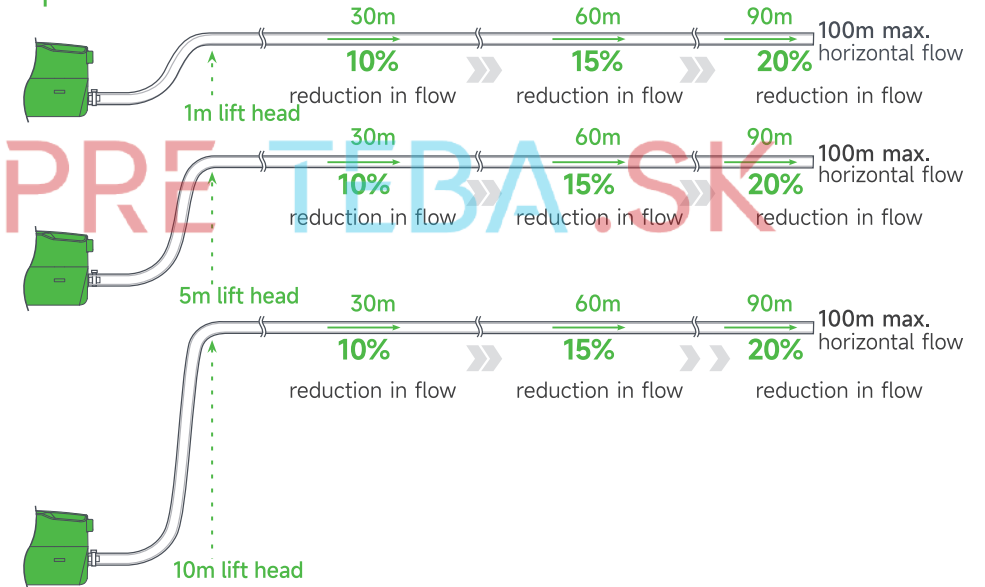

Mini Pump Series Selection Guide

Model	Max. unit output	Applicable A/C	Applicable place	Discharge head(Max)
P20	30,000Btu/h	Split unit, Floor mounted unit	Smaller commercial and domestic units in quiet environments	10m
P38	45,000Btu/h			
P18	30,000Btu/h			
P36	45,000Btu/h			
P16	30,000Btu/h	Ducted units; Floor standing & Chassis units; High wall split systems		7m
P32	45,000Btu/h			
P12	30,000Btu/h			
P12C	30,000Btu/h			

REMARKS:

Cooling capacity conversion

1Btu/h=0.2931W,1W=3.412Btu/h

1USRT=3.517kW,1kW=0.28434USRT



P20/38 Under-mount Condensate Pump

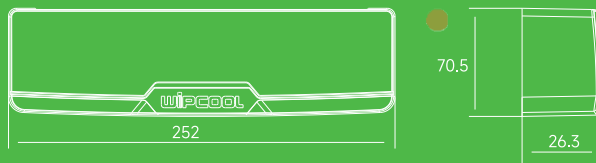

P20/38 Under-mount Condensate Pump



Compact & discreet

PRE TEBA.SK

Removable Reservoir is simple to unclip for cleaning and maintenance.



Flexible installation, it can be mounted on the right or left hand side of unit.



The compact, sleek design is the perfect choice for a convenient installation.



Built-in LED power indicator light



Product Description

The P20/38 Undermount Condensate Pump is an entirely new design specifically manufactured for use in split systems. It can fit very well on right or left hand side of the unit and looks integrated with the air conditioner.

The high performance pump brings the ultra-quiet running, and the removable front cover and reservoir make the easy maintenance.

Perfect for those installations in quiet locations - hotels, theaters, bedrooms and meeting rooms.

Max flow 20/38L/h

Sound level 19/21dB(A)

Max rec. head 10m

Technical Data

Model	P20	P38
Voltage	100V-230V~/50-60Hz	
Discharge Head(Max.)	10m(33ft)	
Flow Rate(Max.)	20L/h(5.3GPH)	38L/h(10GPH)
Tank Capacity	80ml	
Mini Splits up to	30,000btu/hr	45,000btu/hr
Sound Level at 1m	19dB(A)	21dB(A)
Ambient Temp.	0°C-50°C	
Packing	Carton:20pcs	

Flow Rate

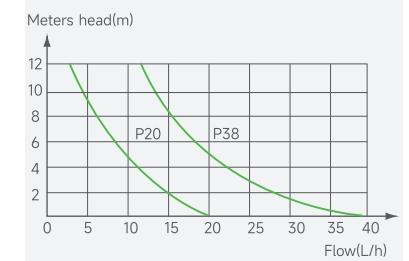



P18/36 Wall-mounted Condensate Pump

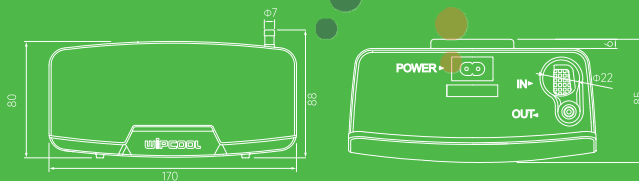



P18/36 Wall-mounted Condensate Pump

Dual Guarantee, High Security

PRE TEBA.SK

 High performance brushless motor, strong power

 Dual sensor control system, improve durability

 Level gauge installed, ensure the accurate installation

 Built-in LED provide visual operating feedback



Product Description

The P18/36 condensate pump is directly installed below the wall-mounted air conditioner. And it is suitable for device which cooling capacity under 45,000 btu/hr.

Adopting a brush-less motor and dual control sensor system, ensuring that the product can operate without obstacles and noise for a long time.

Easy installation and easy access to maintenance making P18/36 be a star product in the WIPCOOL Mini Pumps.

 Max flow
18/36L/h

 Sound level
19/21dB(A)

 Max rec. head
10m

Technical Data

Model	P18	P36
Voltage	100V-230V~/50-60Hz	
Discharge Head(Max.)	10m(33ft)	
Flow Rate(Max.)	18L/h(4.8GPH)	36L/h(9.6GPH)
Tank Capacity	150ml	
Mini Splits up to	30,000btu/hr	45,000btu/hr
Sound Level at 1m	19dB(A)	21dB(A)
Ambient Temp.	0°C-50°C	
Packing	50*36.5*21cm/Cartron:20pcs/G.W.:11.66kgs	

Flow Rate

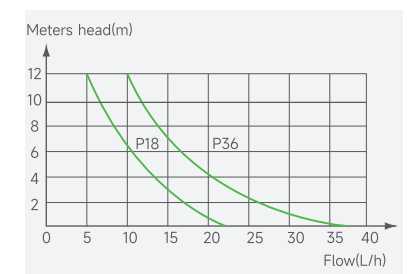



P16/32 Mini Condensate Pump

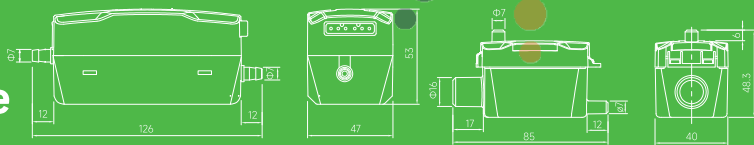

P16/32 Mini-split Condensate Pump

Silent Running, Reliable & Durable



PRE TEBA.SK

Super quiet design, unequalled operating sound level.



Built-in safety switch, avoid the overflow when drainage failure.



Exquisite&compact design, suitable for different spaces.



Built-in LED provide visual operating feedback.



Product Description

The P16/32 mini split condensate pump is most popular in WIPCOOL mini pumps. Widely used in ducted air conditioner, suitable for device which cooling capacity under 45,000btu/hr.

Adopting a brush-less motor and built-in safety switch, ensuring that the pump can operate silently for a long time and guarantee the safety drainage.

Max flow
16/32L/h

Sound level
19/21dB(A)

Max rec. head
10m

Technical Data

Model	P16	P32
Voltage	100V-230V~/50-60Hz	
Suction lift(Max.)	2m(6.5ft)	
Discharge Head(Max.)	10m(33ft)	
Flow Rate(Max.)	16L/h(4.2GPH)	32L/h(8.5GPH)
Tank Capacity	35ml	
Mini Splits up to	30,000btu/hr	45,000btu/hr
Sound Level at 1m	19dB(A)	21dB(A)
Ambient Temp	0°C-50°C	
Packing	Carton:20pcs	

Flow Rate

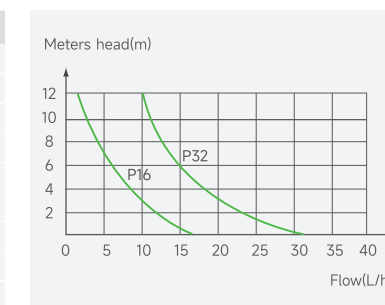



P12 Slim Condensate Pump

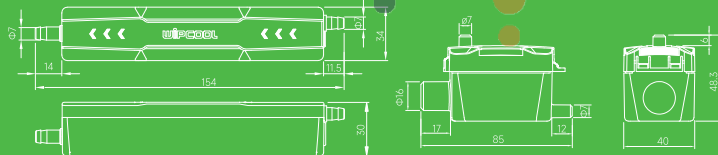

P12 Slim Condensate Pump

Slim and Flexible, Silent & Durable

PRE TEBA.SK

Slimmest body design, flexible installation.



Built-in safety switch, avoid the overflow when drainage failure.



Unique motor balance technology, reduce vibration.



Product Description

The P12 condensate pump adopts slim body design, it is the WIPCOOL's slimmest mini pump.

Specially design for narrow spaces, it is mainly installed in back interior of split air conditioners. It also can be applied in ducted air conditioner, cassette air conditioner. Suitable for the device which cooling capacity under 30,000 btu/hr.

Built-in safety switch and applied unique motor balance technology, ensuring that the pump can operate silently for a long time and guarantee the safety drainage.

Max Flow
12L/h

Sound level
19dB(A)

Max rec. head
7m

Technical Data :

Model	P12
Voltage	100V-230V~/ 50-60Hz
Suction Lift(Max.)	2m(6.5ft)
Discharge Head(Max.)	7m(23ft)
Flow Rate(Max.)	12L/h(3.2GPH)
Tank Capacity	35 ml
Mini Splits up to	30,000btu/hr
Sound Level at 1m	19dB(A)
Ambient Temp	0°C-50°C
Packing	Carton:20pcs

Flow Rate

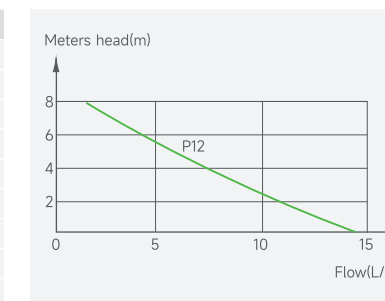



P12C Corner Condensate Pump

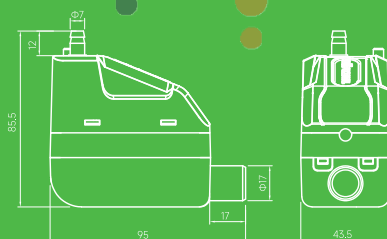

P12C Corner Condensate Pump

Reliable & durable, Silence Running



Perfect fit in trunking elbow, easy installation.



Unique motor balance technology, quiet and no vibration.

Product Description

The P12C corner condensate pump applied the integrated design and can be perfectly installed in the left and right trunking elbow.

It is mainly used for domestic split air conditioners. Suitable for the device which cooling capacity under 30,000 btu/hr.

Built-in safety switch and applied unique motor balance technology, ensuring that the pump can operate silently for a long time and guarantee the safety drainage.

Max flow
12L/h

Sound level
19dB(A)

Max rec. head
7m

Technical Data

Model	P12C
Voltage	100V-230V~/ 50-60Hz
Discharge Head(Max.)	7m(23ft)
Flow Rate(Max.)	12L/h(3.2GPH)
Tank Capacity	45 ml
Mini Splits up to	30,000btu/hr
Sound Level at 1m	19dB(A)
Ambient Temp	0°C-50°C
Packing	Carton:20pcs

Flow Rate

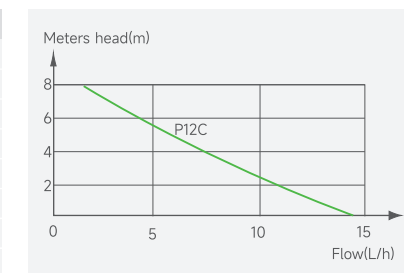

Tank Pumps Series

WIPCOOL focus on innovation and has created a market leading range of tank pumps, which covered from 5 lift levels and flow rates ([10m,40L/h], [3.5m, 110L/h], [4.5m,180L/h], [6.8m,380L/h], [12m,580L/h]), designed to suit a diverse array of applications.

Easy to install and maintain, with features including easy clean tank, plug & play, twist & click non-return valve and built in spirit level. With reliability as the key decision criteria, the tank pumps are designed to perform even under the most challenging of applications.



Why Choose WIPCOOL Tank Pumps?

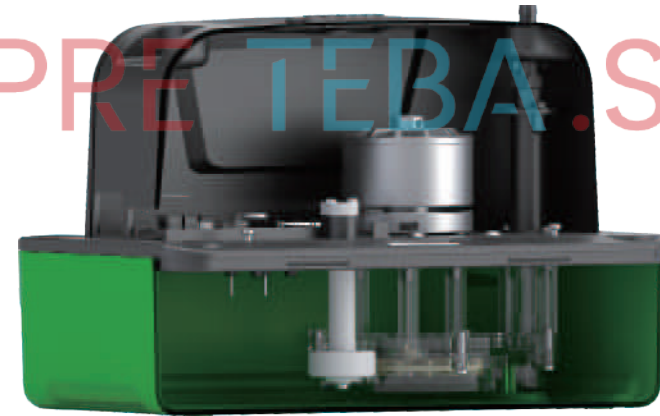

- Easy installation
- Durable running
- High performance
- Industry leading

Tank Pump Series Selection Guide

Model	Max. unit output	Applicable A/C	Applicable place	Discharge head(Max)
P40	45,000Btu/h	Split unit; Cassette unit; Ducted unit; Floor mounted unit	Commercial and domestic units in quiet environments	10m
P110	150,000Btu/h			3.5m
P180	400,000Btu/h	Floor mounted unit; Dehumidifiers; Ice makers; Air handling units (AHUs)	Large commercial units	5m@50Hz 6m@60Hz
P380	500,000Btu/h			6.8m
P580	500,000Btu/h			12m

Remarks:

Cooling capacity conversion

1Btu/h=0.2931W,1W=3.412Btu/h

1USRT=3.517kW,1kW=0.28434USRT



P40
Multi-application
Mini Tank Pump

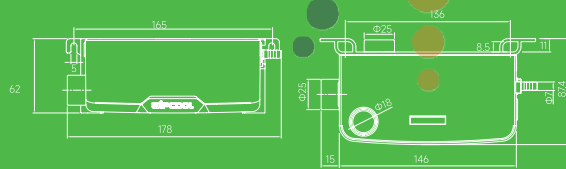

P40
Multi-application
Mini Tank Pump



Reliable Operation, Easy Maintenance

PRE TEBA.SK

Floatless structure, free maintenance for long time working.



High performance brushless motor, strong power



Built-in safety switch, avoid the overflow when drainage failure.



Anti-backflow design, improve the safety drainage

Product Description

Mini tank condensate pump P40 is designed for the multi applications, it has 4 ways for the installation, it can be wall mounted, floor mounted, in-pan or suspended on M8 / M10 rod. Suitable for the device which cooling capacity under 45,000 btu/hr.

P40 inherits the benefits of WIPCOOL mini pumps with high lift & silent running. Adopting the high performance motor, built-in safety switch and probe level sensor, which can be last for long time reliable and silent working.

Max flow 40L/h

Sound level 21dB(A)

Max rec. head 10m

Technical Data

Model	P40
Voltage	100-230V~/50-60Hz
Discharge Head(Max.)	10m(33ft)
Flow Rate(Max.)	40L/h(10.5GPH)
Tank Capacity	200ml
Sound Level at 1m	21dB(A)
IP Protection	IP65
Ambient Temp.	0°C-50°C
Power Consumption	3W
Packing	Carton:20pcs

Flow Rate

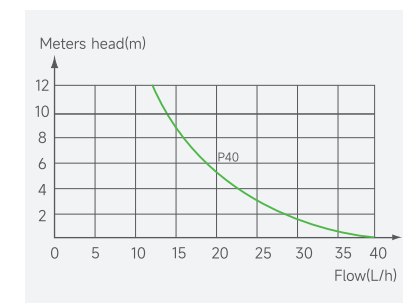



P110
Resistant Dirty
Mini Tank Pump

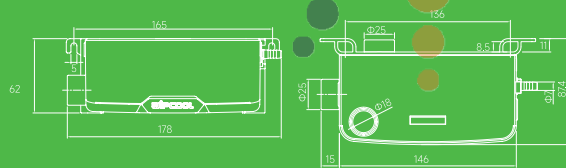

P110
Resistant Dirty
Mini Tank Pump

Reliable Operation, Easy Maintenance

KLÍMA PRE TEBA.SK

Floatless structure, free maintenance for long time working.



Dirt resistant centrifugal pump, longer time for free maintenance.



Forced air cooling motor, ensure stable running.



Anti-backflow design, improve the safety drainage.

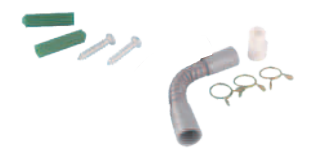

Interchangeable

Product Description

Mini tank condensate pump P110 adopts a dirt resistant centrifugal pump, which is special designed for these poor air environment. It has 4 ways for the installation, wall mounted, floor mounted, in-pan or suspended on M8 / M10 rod. Suitable for the device which cooling capacity under 150,000 btu/hr.

In addition, P110 has a 25mm outlet for more choice, which can be connected directly with 25mm condensate pipe, so it will be very convenient for installation. High power centrifugal pump, built-in safety switch and probe level sensor, which can be last for long time reliable and silent working.

Max flow
110L/h

Sound level
25dB(A)

Max rec. head
3.5m

Technical Data

Model	P110
Voltage	100-230V~/50-60Hz
Discharge Head(Max.)	3.5m(12ft)
Flow Rate(Max.)	110L/h(29GPH)
Tank Capacity	200ml
Sound Level at 1m	25dB(A)
IP Protection	IP65
Ambient Temp.	0°C~50°C
Power Consumption	10W
Packing	Carton:20pcs

Flow Rate

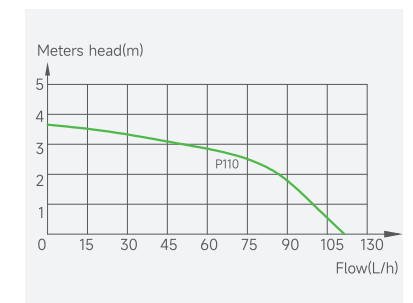



P180 General Tank Pump

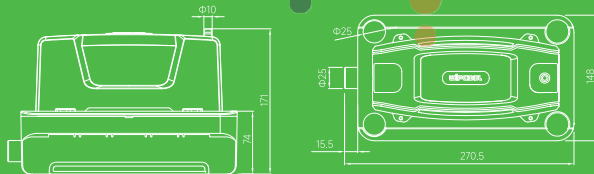

P180 General Tank Pump

Reliable Operation, Easy Maintenance

Floatless structure, free maintenance for long time working.



Automatic reset thermal protection, prolong service life.



Forced air cooling motor, ensure stable running.



Anti-backflow design, improve the safety drainage.

Product Description

The general tank pump P180 can meet the most air conditioning and refrigeration equipment's condensate drainage, which covering discharge lift under 5/6meters. Suitable for the device which cooling capacity under 400,000 btu/hr.

Adopting a dirt resistant centrifugal high-power water pump, built-in safety switch and probe level sensor, make sure the pump can make the reliable running for a long time.

Max flow
280L/h(@50Hz)
350L/h(@60Hz)

Max rec. head
5m(@50Hz)
6m(@60Hz)

Technical Data

Model	P180	
Voltage	230V or 100-120V	
Discharge Head(Max.)	5m(17ft)@50Hz	6m(20ft)@60Hz
Flow Rate(Max.)	280L/h(74GPH)	350L/h(93GPH)
Tank Capacity	1.8L	
Sound Level at 1m	48dB(A)	
Ambient Temp.	0°C-50°C	
Power Consumption	60W	
Packing	Carton:6pcs	

Flow Rate

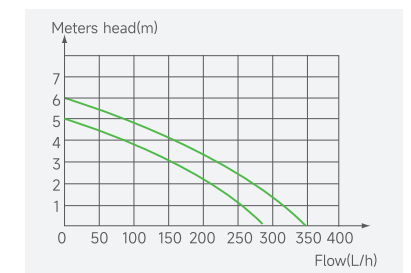

P380 Low Profile Tank Pump

Low Profile, High Lift



Buckle type fixed structure, simple installation.



5 inlets for optional(4 top & 1 side), easy to use.



Low profile design, good fit for those instances where space is at a premium.



Product Description

The P380 tank pump provides the most economical solution when face the a drainage demand of lift within 7 meters and flow rate within 400L/h. Suitable for the device which cooling capacity under 500,000 btu/hr.

Adopting a high performance water pump, built-in safety switch and probe level sensor. Make sure the pump can make the reliable running for a long time. In addition, this pump is only 119mm height, so it's a good fit for those instances where space is at a premium.

Max Flow
380L/h

Max rec. head
6.8m

Technical Data

Model	P380
Voltage	100V-230V~/50-60Hz
Discharge Head(Max.)	6.8m(22ft)
Flow Rate(Max.)	380L/h(100GPH)
Tank Capacity	1.8L
Sound Level at 1m	28dB(A)
Ambient Temp.	0°C-50°C
Power Consumption	20W
Packing	Carton:6pcs

Flow Rate

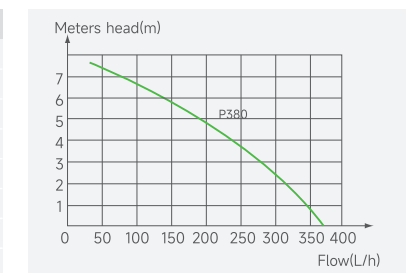

P380 Low Profile Tank Pump

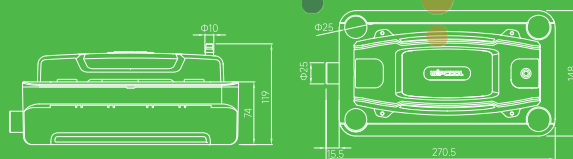



**P580
Super Performance
Tank Pump**

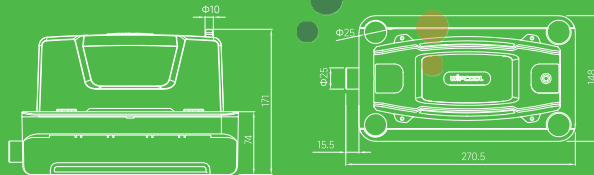

**P580
Super Performance
Tank Pump**

Ultra-high Lift, Big Flow Rate

PRE TEBA SK
Super performance (12m lift head, 580L/h flow rate)



Forced air cooling brushless motor, ensure stable running.



Anti-backflow design, guarantee the safety drainage.



Dual sensor control system, improve durability.

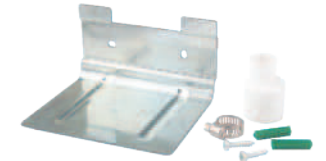

Product Description

The P580 tank pump provides the most economical solution under extreme drainage conditions (12 meter lift height, 600L/h flow rate), Suitable for the device which cooling capacity under 500,000 btu/hr.

Adopting brushless motor, dirt resistant high-power centrifugal water pump, built-in safety switch and dual control level sensor (probe & float). Ensuring that the product can operate reliable for a long time and safely discharge condensate.

 Max flow
580L/h

 Max rec. head
12m

Technical Data :

Model	P580
Voltage	230V~/50-60Hz or 100-120V~/50-60Hz
Discharge Head(Max.)	12m(40ft)
Flow Rate(Max.)	580L/h(153GPH)
Tank Capacity	1.8L
Sound Level at 1m	60dB(A)
Ambient Temp.	0°C-50°C
Power Consumption	85W
Packing	Carton:6pcs

Flow Rate

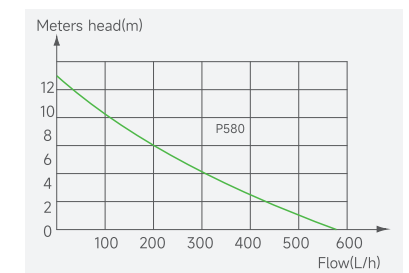



Supermarket Pump

WIPCOOL supermarket condensate pump applied the compact design, Ideal for cold produce display cabinets in supermarkets and convenience stores. Especially suitable to handle condensate from supermarket refrigerated display cabinets.

It is extremely easy to install and maintain. Built-in high level safety switch which will either enable the plant to be switched off or sound an alarm in the event of a pump failure.

Why Choose WIPCOOL Supermarket Pump

- Easy maintenance
- Time saving
- High performance
- Industry leading

Supermarket Pump Selection Guide

Model	Max. unit output	Applicable	Applicable place	Discharge head (Max)
P120S	300,000Bth/h	Single and multiple refrigeration units; Cold store cabinets	Cold stores, Supermarkets	30m
P360S	500,000Bth/h			36m

Remarks:

Cooling capacity conversion
 $1\text{Btu/h}=0.2931\text{W}, 1\text{W}=3.412\text{Btu/h}$
 $1\text{USRT}=3.517\text{kW}, 1\text{kW}=0.28434\text{USRT}$



**P120S
Economic
Supermarket Pump**

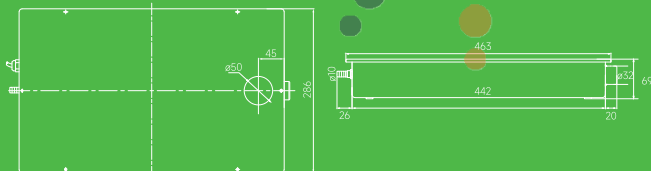

**P120S
Economic
Supermarket Pump**



Special Design, Simple Installation

PRE TEBA.SK

Made of stainless steel case with 3L large reservoir



Ideal for cold produce display cabinets in supermarkets and convenience stores



Low profile (69mm height) for extremely easy to install and maintenance.



Built of heat resistant material, suitable for handling 70°C high temperature water

Product Description

The P120S is specially designed to handle condensate from supermarket refrigerated display cabinets, it is extremely easy to install and maintain. The compact design of the pump facilitates installation under low-slung display cabinets, and it remove water during the defrost cycle.

Including a easy clean stainless tank which can handle the 70°C hot water, non return valve 2inlets for optional(top or side). Effectively pumps away defrost water and filters debris.

- Max flow 120L/h
- Max rec. head 30m
- Tank capacity 3L

Technical Data

Model	P120S
Voltage	230V~/50-60Hz or 100-120V~/50-60Hz
Discharge Head(Max.)	30m(98ft)
Flow Rate(Max.)	120L/h(32GPH)
Tank Capacity	3L
Sound Level at 1m	40-62dB(A)
Water Temp.	Max 75°C
Power	30W
Packing	Carton:2pcs

Flow Rate

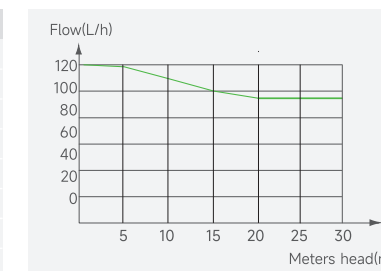



**P360S
Premium
Supermarket Pump**

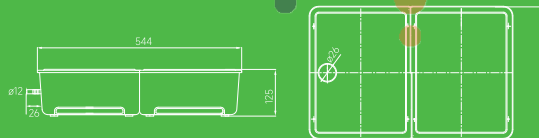

**P360S
Premium
Supermarket Pump**

Lightweight Design, Reliable & Durable



PRE TEBA.SK

Made of robust plastic, effectively pumps away defrost water and filters debris.



Low profile design, ideal for cold produce display cabinets in supermarkets and convenience stores.



Built-in high level safety switch which will either enable the plant to be switched off or sound an alarm in the event of a pump failure.

Product Description

Made of lightweight and robust plastic, the P360S is specially designed to handle condensate from supermarket refrigerated display cabinets, it is extremely easy to install and maintain.

Built-in a dual-control system with a powerful motor, including a durable ABS tank, non return valve, 2 inlets for optional (top or side). Effectively pumps away defrost water and filters debris.

Max flow 360L/h

Max rec. head 36m

Tank capacity 11L

Technical Data

Model	P360S
Voltage	230V~/50-60Hz or 100-120V~/50-60Hz
Discharge Head(Max.)	36m(118ft)
Flow Rate(Max.)	360L/h(95GPH)
Tank Capacity	11L
Sound Level at 1m	60dB(A)
Water Temp.	0-40°C
Power	80W
Packing	Carton:2pcs

Flow Rate

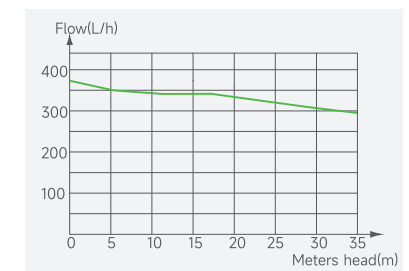



P15J Condensate Atomization Pump

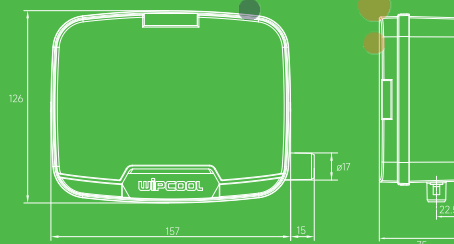

P15J Condensate Atomization Pump

Create Wealth From Waste Energy, Saving & CO2 Emission

PRE TEBA.SK

Stop condensate water's dripping and free of condensate pipe's installation



Increased the heat exchange efficiency by water evaporation absorbs a lot of heat



Enhanced refrigeration effect of the system obviously, saving the energy



Integrated usage



Interchangeable



Split usage

Product Description

P15J is for atomizing air conditioner condensate drainage. The system consists of only a few elements to reduce the risk of malfunctions and failures.

A central apparatus (pump and diaphragm) protected by a white box, a tube to collect the discharge water, a small tube to dispose of the mist and an end nozzle that only need connecting together to solve the condensate drainage problem in a practical, fast and cost-effective way. And Enhanced refrigeration effect of the system at the same time.

 Flow rate
10L/h

 Working pressure
3bar

Technical Data

Model:	P15J	Tank Capacity:	35ml
Voltage:	230V~/50-60Hz 100-120V~/50-60Hz	Mini Splits up to:	30,000btu/hr
Flow Rate(Max.):	10L/h(2 nozzles)	Sound Level at 1m:	40-45dB(A)
Pressure:	3bar	Power:	25W
Suction lift(Max.)	1.5m(5ft)	Ambient Temp:	0°C-50°C
Packing	Carton:12pcs		



PT-25 Floating-ball Condensate Trap

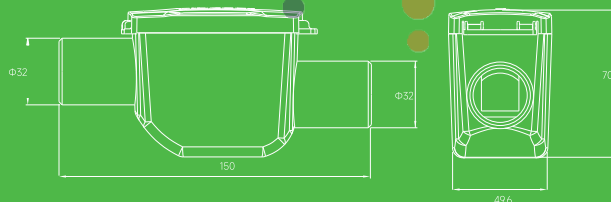

PT-25 Floating-ball Condensate Trap

Smooth Drainage, Enjoy Fresh Air



Lightweight design, easy to install.



Anti blockage, prevent smelly & insect-resistant.



Controlled by floating ball valve, suitable for all seasons.



No need to inject water when it is dry.

Product Description

The WIPCOOL floating-ball condensate trap is designed to solve the problems of outdoor air reflux, odor, and harmful insect invasion in the condensate discharge pipeline of the air conditioning.

By floating the ball up and down, the disadvantage of traditional water traps not being able to perform their water sealing function during dry seasons is avoided.

Adopting a buckle design, it is easy to install & maintain, and provides users with a fresh indoor environment.

Exploded figure

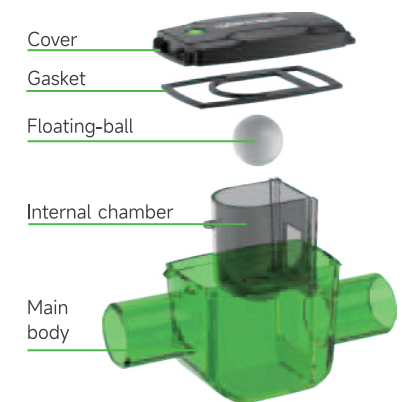

Technical Data

Model	PT-25
Inner diameter	Ø25
Outer diameter	Ø32
Negative pressure	1200Pa
Gross weight	115g
Packing	Carton:45pcs

PT-25V Vertical Type Condensate Trap

Smooth Drainage, Enjoy Fresh Air

KLÍMA PRE TEBA.SK

Lightweight design, easy to install



Water storing design, prevent smelly & insect-resistant



Built-in gasket seal, ensure no leakage



Made of PC material, anti-ageing & corrosion-resistant



Product Description

The WIPCOOL Vertical Type condensate trap is designed to solve the problems of outdoor air reflux, odor, and harmful insect invasion in the condensate discharge pipeline of the air conditioning.

The condensate trap controlled by a sensitive rebound valve, which will open by the gravity of the creating condensate water and close when there is no condensate water created. Adopting a buckle design, it is easy to install, easy to maintain, and provides users with a fresh indoor environment.

Exploded figure

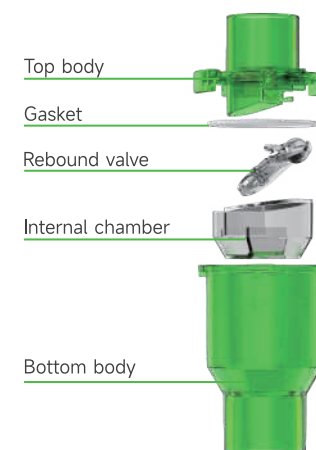

Technical Data

Model	PT-25V
Inner diameter	Φ25
Outer diameter	Φ32
Negative pressure	1200Pa
Gross weight	60g
Packing	Carton:60pcs

PT-25V Vertical Type Condensate Trap

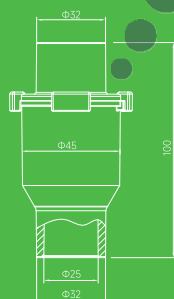

PLC-1 Intelligent Level Controller

Intelligent, Security



Built in indicator - provide visual operating feedback



Sensitive control - cut off power supply automatically in case of drainage failure



Easy to install - Suitable for all WIPCOOL condensate pumps which have built-in safety switch

Instructions



Normal drainage status
All devices are working normally



Failure drainage status
Output was cut off when water reaches alarm level to trigger safety switch. To prevent refrigeration equipment continue to generating the condensate water.

Product Description

WIPCOOL intelligent level controller is designed to solve the problem of condensed water drainage in the working process of dehumidifying equipment or refrigeration equipment.

It can automatically cut off the power supply of the equipment through the built-in intelligent chip control, so as to avoid the occurrence of problems such as bubble water of the equipment on the roof of home decoration. Its appearance is exquisite and its wiring is simple, so it is the best companion of drainage pump.

Technical Data

Model	PLC-1
Voltage	230V~/50-60Hz
Power of applicable equipment (Max.)	3000W
Max Carry Current	16A

Dimensions

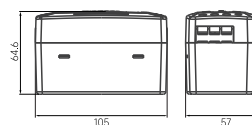

DT-1/2/3 Condensate Drain Tubing

Flexible, durable and non toxic



Product Description

DT-1/2/3 are for use with air conditioning and refrigeration condensate drains, condensate pump discharge lines and humidifier overflow drain lines. These tubing are designed to be kink resistant, lightweight and flexible. Made of high quality PVC materials with smooth interior and exterior that prevents sediment accumulation, allows easy flow.

The tubing are easy to shape, bend and install. DT-1 is suitable for these mini pumps and DT-2 is suitable for tank pumps. DT-3 has the good insulation performance that can thoroughly solve the problem of condensate forming on the outside of the condensate drain line.

Technical Data

Model	DT-1	DT-2	DT-3
Material	PVC	PVC	PVC+PE
Size	Φ6mm x Φ9mm	Φ8mm x Φ12mm	Φ6mm x Φ9mm
Length	100m	100m	50m

HVAC maintenance

Heating, Ventilation and Air Conditioning (HVAC) is a vital component of all buildings and it requires regular maintenance like all other appliances or systems installed.

Regular preventive maintenance of your HVAC system will bring the 6 benefits.

1, Lower energy costs 2, Reduced repair costs 3, Fewer Emergency Repairs 4, Sustainability 5, Higher life span of your system 6, Health and safety.

In WIPCOOL, we have been committed to developing HVAC system maintenance solutions to improve the efficiency and speed of maintaining HVAC and refrigeration equipment. We help customers simplify their ongoing, planned, and predictive maintenance by providing HVAC maintenance tools to maintain optimal system operation.

We are proud to have developed industry leading products in condensers, evaporator coil cleaning machines, chiller tube cleaner, refrigeration compressor oil charging pump and more.



The Importance Of HVAC Coils Cleaning

Air conditioners "coils" like evaporator coils and condenser coils are the primary method for heat exchange, whether that be removing heat from the air (cooling) or pushing heat back into the air (heating).

The below 3 aspects will depend on having clean coils.

1, Maximum heat transfer is dependent on having clean coils

In addition to energy consumption, other by products impact your coils. Acid formation can occur under these conditions, leading to lubricant breakdown and ultimately equipment failure. Cooling air passing through the coils contains dust, dirt, pollen, moisture and other contaminants clogging the coils promoting the growth of organisms and thereby generating odors throughout an occupied space.

2, System longevity is dependent on having clean coils

In addition, the evaporator coil and its condensate pan can become fouled with pollen, mold spores and other bio contaminants and can have an adverse effect on indoor air quality. With all the moisture around the evaporator coil, it can become a breeding ground for bacteria and mold.

3, Indoor air quality is dependent on having clean coils

Clean coils the right way. While any attempt to clean coils on a consistent basis can be applauded, there are right ways and wrong ways of cleaning. Cleaning the wrong way can actually do more harm than good.

Different with pump sprays (low pressure and flow and not very effective in penetrating most coils beds) and pressure washers (uses pressure that's too high and damages fins), WIPCOOL can supply you a full range of cleaning machines which have balanced pressure and water volume that's safe on coils, pressure range from 2BAR (30PSI) to 40 BAR (580PSI), provide you with AC power and Lithium battery power. And supply you with cool water, hot water and steam cleaning mode, to meet the cleaning needs of different occasions.



How To Choose A Coil Cleaning Machine?



Make the regular cleaning with cleaning equipment, especially for condenser and evaporator, is one of the fastest and safest ways to ensure that the equipment operates with the highest efficiency and keep the indoor air healthy and clean. The following 3 points should be considered when choosing a cleaning machine.

1, Water

Depending on where the coils are located, you may have to bring your own water to the job, so finding this out beforehand is very important. When it comes to cleaning in remote locations, the cleaning machine with on-board water tank will help get cleaning done quickly. Our C10BW HVAC Coil Cleaning machine is designed for this kind of flexibility.

2, The size of HVAC system

Another very important factor to consider when cleaning coils is their thickness. Thick coils like these commercial & industrial HVAC system are usually pretty challenging to clean efficiently. Cleaning them right requires a perfect combination of higher volumes of water and pump pressure to penetrate far enough into thick coil beds to flush out dirt and debris. And the domestic unit is relatively simple, the cleaning pressure for outdoor unit should be a little higher than indoor unit, so choose a dual-pressure cleaning machine(3-10bar) will be suitable for you.

3, Power

Knowing if there will be electrical power in an area you will be cleaning coils is equally as important as knowing if there will be water available. Considering that some outdoor unit installed on rooftop without power socket. It is hard to find the AC power source, so a portable, cordless cleaning machine is necessary.

Coil Cleaning Machine Selection Guide

Model	Pressure	Type	Power
C10	5/10bar	Indoor-outdoor unit(Domestic), Indoor unit(Commercial)	AC Power
C10B	5/10bar	Indoor-outdoor unit(Domestic), Indoor unit(Commercial)	Li-ion battery
C10BW	5/10bar	Indoor-outdoor unit(Domestic), Indoor unit(Commercial)	Li-ion battery
C28T	5-28bar(adjustable)	Indoor-outdoor unit (Domestic, Commercial)	AC Power
C28B	7/20bar(adjustable)	Indoor-outdoor unit (Domestic, Commercial)	Li-ion battery
C40T	10-40bar(adjustable)	Indoor-outdoor unit (Domestic, Commercial)	AC Power
C110T	10-110bar(adjustable)	Outdoor unit (Commercial,Industrial)	AC Power
C30S	6bar(steam)	Indoor unit	AC Power
C35S	10/30bar(cool water)	Indoor-outdoor unit (Domestic, Commercial)	AC Power

C10 Portable Coil Cleaning Machine

Dual Pressure Cleaning Professional & Efficient

PRE TEBA.SK

Reel structure, free to release and retract the inlet and outlet hose.



Two pressure optional, meet the different cleaning requirement.



Built-in pressure controller, suspend automatically.



Medium pressure, safety for coils cleaning to avoid fins damage.

Product Description

C10 is a professional air conditioning coil cleaning machine that uses AC power supply and can operate in low pressure mode of 3-5 bar and high pressure mode of 7-10 bar. The pressure can be adjusted by simply pressing the top button, allowing for safety cleaning of the indoor and outdoor coils.

Because of the self priming function, so you can use an external water tank to solve water source problem. At the same time, it is equipped with various professional cleaning accessories, such as a 290° rotating nozzle with a 37cm extension wand, which can easily penetrate into narrow gaps for cleaning. The product is lightweight and portable, and can be carried away with one hand.

Flow rate
4L/min

Automatic
start and stop

Adjustable
pressure
5/10Bar

Technical Data

Model	C10
Voltage	230V~/50-60Hz or 100-120V~/50-60Hz
Working Pressure	3-5 / 7-10 bar(Dual)
Flow Rate (Max.)	4L/min
Motor Power	100W
Weight	3.7kg
Inlet Hose	2.5m
Outlet Hose	5.0m
Packing	Carton:2pcs

Accessories



C10 Portable Coil Cleaning Machine

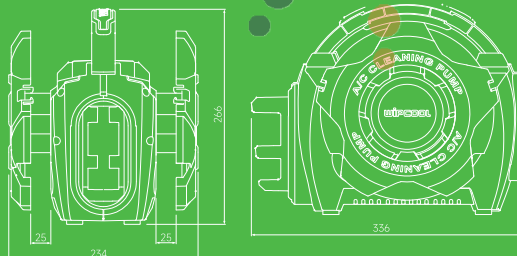



C10B Cordless Coil Cleaning Machine

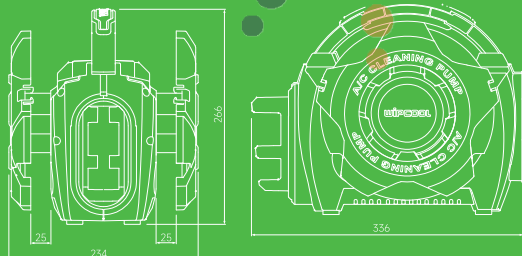

C10B Cordless Coil Cleaning Machine

Battery Powered, Cordless Cleaning



PRE TEBA

Reel structure, free to release and retract the inlet and outlet hose.



Two pressure optional, meet the different cleaning requirement.



Built-in pressure controller, suspend automatically.



Li-ion battery powered, get rid of site power limitations.

Product Description

C10B is a professional cordless air conditioning cleaning machine that can operate in low pressure mode of 3 to 5 bar and high pressure mode of 7 to 10 bar. The pressure selection can be adjusted by simply pressing the top button, allowing for safety cleaning of the inner and outer coils.

Because of the self priming function, so you can use an external water tank to solve water source problem. At the same time, it is equipped with various professional cleaning accessories, such as a 290° rotating nozzle with a 37cm extension wand, which can easily penetrate into narrow gaps for cleaning. The product is lightweight and portable, and can be carried away with one hand.

Using an 18V Li-ion battery for power supply means there is no need to search for AC power sources everywhere, especially when cleaning outdoor air conditioning units. In addition, in order to maximize the utilization of existing Li-ion batteries in users' hands and reduce their purchasing costs, we have specially developed 6 mainstream brand battery adapters (Bosch, Makita, Panasonic, Dewalt, Worx, and Milwaukee), which can easily be compatible with the use of the above brand batteries.

- 4 l/min Maximum flow rate
- Automatic start and stop
- 5/10Bar Adjustable pressure
- Compatible to 6 mainstream brand battery

Technical Data

Model	C10B
Voltage	18V(AEG/RIDGID interface)
Working Pressure	3-5 / 7-10 bar(Dual)
Flow Rate (Max.)	4L/min
Motor Power	80W
Weight	3.7kg(w/o battery)
Inlet Hose	2.5m
Outlet Hose	5.0m
Reference Running Time	50-120mins (4.0Ah Li-ion battery)
Reference Charging Time	210mins(4.0Ah Li-ion battery)
Remarks	Due to the strict transportation terms, we can not include any Li-ion battery, you can choose our battery adapters (Bosch & Makita standard equipped) for use your own batteries.
Packing	Carton:2pcs

Accessories

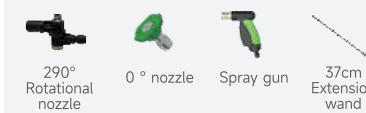

Battery Adapters (Optional)See P112 **Battery converter (Optional)See P112**

6 Adapters for choice
Perfect fit for 6 brands of batteries





C10BW Integrated Coil Cleaning Machine

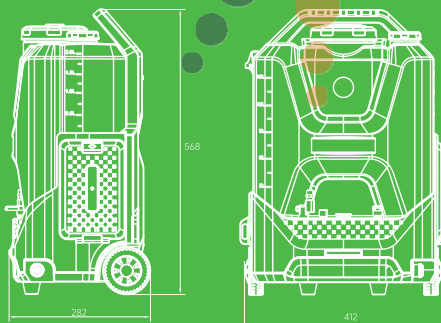

C10BW Integrated Coil Cleaning Machine

Integrated Solution, Mobility Cleaning

KLÍMA PRE TEBA

Excellent mobility
Equipped with wheels and push handle

2 Power for choice
AC powered or 18V Li-ion powered

Integrated Solution
18L clean water tank with 2L chemical tank

Excellent mobility
Also available with a back strap for ultimate portability.



Product Description

The integrated coil cleaning machine C10BW is ideal for cleaning in locations where water and power may be inaccessible. It is powered by AC power or 18V lithium battery, and has 6 battery adapters(optional) for your choice, you can use your own batteries if your battery compatible any one in these 6 adapters. In addition, this machine give you a full integrated coil cleaning solution. A 18L clean water tank with a 2L chemical tank. And trolley case design bring with a excellent mobility. A optional back strap can completely liberate your both hands to carry the cleaning machine and climb the ladder to a specific jobsite (such as attic, roof, etc).So it can be used for just about any coil cleaning application. Different from the traditional high pressure cleaning machine and low pressure sprayer. The machine is special design and safety for HVAC coils, provide two cleaning pressure. It can be selected between 5bar/10bar according the different cleaning occasions, give you the cleanest coils you ever had!

- Automatic start and stop
- Compatible to 6 mainstream brand battery
- Flow rate 4 L/min
- Adjustable pressure 5/10Bar

Technical Data :

Model	C10BW
Voltage	18V(AEG/RIDGID interface)
Pressure	3-5 / 7-10 bar(Dual)
Flow rate(Max.)	4L/min
Reference Running time	50-120mins(4.0AhLi-ion battery)
Reference Charging time	210mins(4.0AhLi-ion battery)
Motor Power	80W
Tank Capacity	18L clean water tank + 2L chemical tank
Outlet Hose	5m
Weight(dry)	6.6kg(w/o battery)
Remarks	Due to the strict transportation terms, we can not include any Li-ion battery, you can choose our battery adapters for use your own batteries.
Packing	Carton:1pcs

Accessories





C28T
Crankshaft-driven
High Pressure
Cleaning Machine

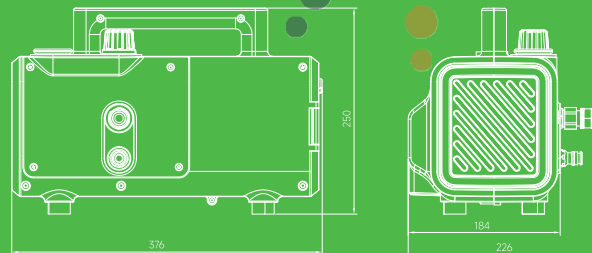

C28T
Crankshaft-driven
High Pressure
Cleaning Machine

Industrial Grade
Reliable & Durable



Variable pressure (5-28bar) for optimal flexibility to meet the different occasions.



Crankshaft-driven pump with ceramic-coated pistons for long service life.



Large oil level sight glass, easily accessible to check oil status, and ready for oil change in time for maintenance.

Product Description

C28T is a professional high-pressure equipment, special design for HVAC cleaning industry, it has a crankshaft-driven pump with ceramic-coated pistons for long service life, allowing it to work continuously.

With its adjustable working pressure from 5-28bar for optimal flexible cleaning, it is able to remove the most dirt from condenser & evaporator coils without damaging these sensitive fins.

Great portability. Its small size and light weight allow it to be carried in one hand.

- Flow rate 4.5 L/min
- Adjustable pressure 5-28bar
- Automatic start and stop
- Continuous operation 4-6h

Technical Data

Model	C28T
Voltage	230V~/50-60Hz or 100-120V/50-60Hz
Working Pressure	5-28bar(Adjustable)
Flow Rate(Max.)	4.5L/min
Output Power	3/4HP
Weight	8.5kg
Water Pipe	2m inlet hose, 7m outlet Hose
Packing	Carton:1pcs

Accessories





C28B Crankshaft-driven Cordless Cleaning Machine

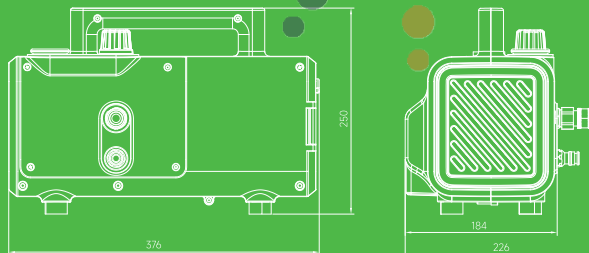

C28B Crankshaft-driven Cordless Cleaning Machine



Industrial Grade
Mobility Cleaning

KLÍMA PRE TEBA

Dual cleaning pressure (7/20bar) for optimal flexibility to meet the different occasions.



Crankshaft-driven pump with ceramic-coated pistons for long service life.



Large oil level sight glass, easily accessible to check oil status, and ready for oil change in time for maintenance.



Li-ion battery powered, get rid of site power limitations.

Product Description

C28B is a professional cordless high-pressure equipment, special design for HVAC cleaning industry, it has a crankshaft-driven pump with ceramic-coated pistons for long service life, allowing it to work continuously.

With its 2 adjustable working pressure from 7/20bar for optimal flexible cleaning, it is able to remove the most dirt from condenser & evaporator coils without damaging these sensitive fins.

Using an 18V Li-ion battery for power supply means there is no need to search for AC power sources everywhere, especially when cleaning outdoor air conditioning units. In addition, in order to maximize the utilization of existing Li-ion batteries in users' hands and reduce their purchasing costs, we have specially developed 6 mainstream brand battery adapters (Bosch, Makita, Panasonic, Dewalt, Worx, and Milwaukee), which can easily be compatible with the use of the above brand batteries.



Flow rate
4 L/min



Dual pressure
7/20bar



Automatic
start and stop



Compatible to
6 mainstream
brand battery

Technical Data

Model	C28B
Voltage	18V(AEG/RIDGID interface)
Working Pressure	7/20bar
Flow Rate(Max.)	4 L/min
Output Power	1/2HP
Weight	5.0kg
Water Pipe	2m inlet hose, 7m outlet Hose
Reference Running Time	30-45min(18V/9.6Ah)
Remarks	Due to the strict transportation terms, we can not include any Li-ion battery, you can choose our battery adapters for use your own batteries.
Packing	Carton:2pcs

Accessories



Battery Adapters(Optional)

6 Adapters for choice, Perfect fit for 6 brands of batteries





C40T Adjustable High Pressure Cleaning Machine

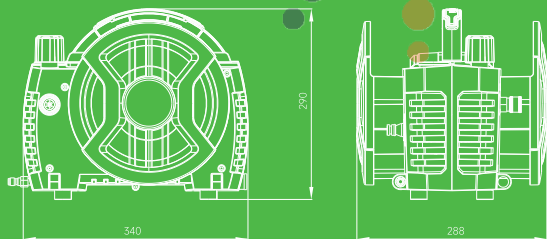

C40T Adjustable High Pressure Cleaning Machine

Variable Pressure, Professional Cleaning

PRE **TEBA**

Quick connection
All accessories are easy to install and disassemble

Self-intake function
pump water from buckets or storage tanks

Overhead pressure gauge
Easy to read the exact pressure.

Pressure adjust knob
Adjust pressure to meet different cleaning requirements

Ceramic-coated pistons
Long service life, sturdy and reliable



Product Description

C40T is a comprehensive tool designed for professional cleaning of commercial and industrial equipment in the HVAC industry.

This machine is equipped with an easy-to-use knob. It makes it possible to select the pressure value during operation from 10 to 40 bar, allows for precise and quick removal of dirt from hard-to-reach places inside the device.

The great advantage of this machine equipped with many professional accessories, including a foaming set and foam nozzle, so you no need a manual foam machine. 2 extension wand(36cm), 220° rotational nozzle which can easily penetrate into narrow gaps for cleaning.

What's more, the integrated storage design make you can put all of the accessories in the both side of machine with out any omissions. At the same time, the compact size and lightweight of the machine make it easy to carry.

Maximum flow rate
6 L/min

Adjustable pressure
10-40 bar

Automatic
start and stop

Technical Data

Model	C40T
Voltage	230V-/50-60Hz or 100-120V/50-60Hz
Working Pressure	10-40bar
Flow Rate(Max.)	6L/min
Motor Power	1HP
Weight	8.0kg
Water Pipe	2m inlet hose, 7m outlet Hose
Packing	Carton:1pcs

Accessories





C110T
Crankshaft Driven
Super High
Pressure Washer

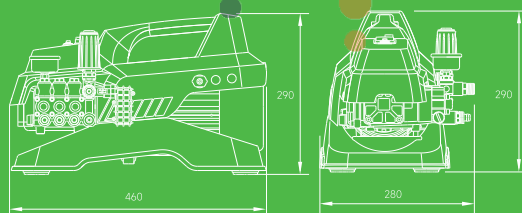

C110T
Crankshaft Driven
Super High Pressure Washer

Compact & Durable, Strong Power



PRE TEBA

Variable pressure (10-90bar) for optimal flexibility to meet the different occasions.



Crankshaft-driven bass pump with ceramic-coated pistons for long service life.



Large oil level sight glass, easily accessible to check oil status, and ready for oil change in time for maintenance.



Dolly is available separately
Model No: Dolly110

Product Features

C110T is a professional high-pressure heavy duty equipment, small on the outside and big on the inside, it has a crankshaft-driven brass pump, allowing it to work continuously.

It's simply the best solution for an all-around industrial pressure washer to clean industrial environment and for facility management and maintenance needs.

Great portability. Its small size allows it to be carried in one hand. Or it can be mounted on a trolley for convenience.

- 10-90bar Adjustable pressure
- Input Power 3HP
- Automatic Start & stop
- 4-6h Continuous operation

Technical Data

Model	C110T
Voltage:	230V~/50-60Hz or 115V~/60Hz
Max. Pressure:	110 bar
Operation Pressure:	90 bar
Input Power:	3HP
Inlet Water Pressure:	3bar
Flow Rate:	9L/min
Weight:	26.0kgs
Packing	Carton:1pcs

Accessories



C30S Steam Cleaning Machine

Strong Steam, Ultimate Clean

PRE TEBA.SK

Remote control Intelligent spray gun, convenient operation with high efficient



Humanized configuration with LCD touch display and voice reminder



Drum pump body structure, freely and quickly storage inlet and outlet pipes



Hot steam with high pressure, Pure physical sterilization Ozone disinfection, safe and efficient sterilization



*The data comes from Guangzhou Institute of Microbiology Co.,Ltd.
TEST REPORT NUMBER:XJ20222393

Product Description

C30S is a multi-functional device for comprehensive cleaning of your home air conditioner. The machine enables work in up to 5 modes: steam, hot water, cold water, pulse, ozone treatment. The steamer also features a LCD touch screen and voice messages informing about the device's operating mode.

Thanks to these functions, you can not only easily clean, but also disinfect the air conditioner and get rid of unpleasant odors.

The hot steam coming from the nozzle of the device may reach the temperature in the range of 130°C-150°C, so you will not only clean the inside of the air conditioner without the use of additional detergents, but also disinfect its interior.

The process of getting rid of dangerous bacteria and other microbes will be completed by the ozone treatment mode, which kills 99.9% of microorganisms and get rid of the nasty smell.

In hot water mode, the device heats the water to a temperature of 60-85 °C, with an operating pressure of 3-6 bar, so there is no fear of damaging the internal components of home air conditioning.

The machine also includes many professional accessories, such as 90° bent spray nozzle, nylon brush, long steam nozzle, and a 290° rotational spray nozzle, which will help you complete the professional and deep cleaning.

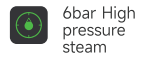

6bar High pressure steam

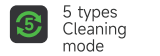

5 types Cleaning mode

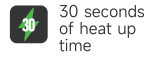

30 seconds of heat up time

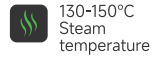

130-150°C Steam temperature

Technical Data

Model	C30S	
Voltage	230V~/50-60Hz	100-120V~/50-60Hz
Power(Max.)	3300W	2000W
Flow Rate(Max.)	3L/min	3L/min
Working Pressure(Max.)	3-6bar	3-6bar
Suction Lift(Max.)	1.5m	1.5m
Steam Temp.	130-150°C	120-130°C
Water Outlet Temp.(Max.)	60-85°C	50-75°C
Water Pipe	1.5m Inlet hose,4m Outlet hose	
Packing	Carton:1pc	

Accessories



90° bent spray nozzle(35cm)



Nylon brush



Long steam nozzle(10cm)



290° rotational spray nozzle (26cm)

C30S Steam Cleaning Machine

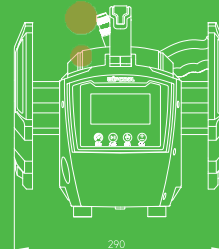
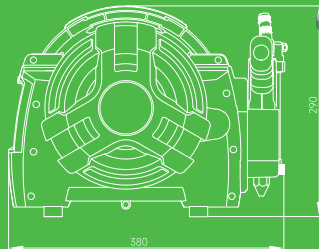



C35S High Pressure Steam Cleaning Machine

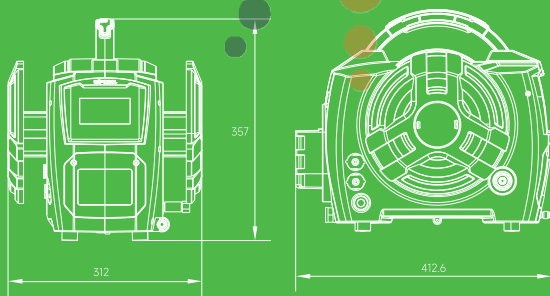

C35S High Pressure Steam Cleaning Machine

Higher Pressure, Ultimate Clean



Remote control Intelligent spray gun, convenient operation with high efficient



Humanized configuration with LCD touch display and voice reminder



Drum pump body structure, freely and quickly storage inlet and outlet pipes



Hot steam with high pressure, Pure physical sterilization Ozone disinfection, safe and efficient sterilization

Product Description

C35S is an upgraded version of C30S, it keeps the same function of steam, hot water, pulse, ozone treatment. But it increases the cleaning pressure of cool water to be 10bar/30bar, so it will be perfected for cleaning HVAC coils with high efficiency. Thanks to these functions, you can not only easily clean, but also disinfect the air conditioner and get rid of unpleasant odors.

The hot steam coming from the nozzle of the device may reach the temperature in the range of 130°C-150°C. so you will not only clean the inside of the air conditioner without the use of additional detergents, but also disinfect its interior.

The process of getting rid of dangerous bacteria and other microbes will be completed by the ozone treatment mode, which kills 99.9% of microorganisms and gets rid of the nasty smell.

The machine also includes many professional accessories, such as 290° rotational nozzle, 0°&15° nozzle, nylon brush, long steam nozzle, 1*36cm extension wand, which will help you complete the professional and deep cleaning.

10/30 bar
Dual pressure
cleaning

5 types
Cleaning mode

30 seconds
of heat up time

130-150°C
Steam
temperature

Technical Data

Model	C35S	
Voltage	230V~/50-60Hz	100-120V~/50-60Hz
Power(Max.)	2800W	2000W
Flow Rate(l)	5L/min(cool water)	5L/min(cool water)
Working Pressure(Max.)	10/30 bar(dual)	10/30 bar(dual)
Suction Lift(Max.)	1.0m	1.0m
Steam Temp.	130-150°C	120-130°C
Water Outlet Temp.(Max.)	50-60°C	45-55°C
Water Pipe	1.5m Inlet hose, 4.0m Outlet hose	
Packing	Carton:1pc	

Accessories



C1FC Foaming Cannon

- EASY to install, 1/4" quick connection plug to pressure washer gun or wand.
- Fit for WIPCOOL high pressure cleaning machines.
- Adjustable nozzle for accurate mixing and foam generation.
- Ideal for car washing; roofs, windows washing, specially for hvac coil cleaning



1/4" quick connection



Adjustable nozzle



Thick Snow Foam

Model	C1FC
Tank Capacity	1L
Connection Size	1/4"
Suitable For	C28T,C28B,C40T,C35S,C110T



CSC-2 Ceiling A/C Cleaning Cover

- Widened collection surface, fully catch the waste water during cleaning
- Integrated connection design, make the assemble and disassemble easily
- Whole piece of waterproof fabric cloth to avoid any water leakage
- Come with a stretched suspension plate, free to adjust cover height easily



Foldable design



Integrated storage

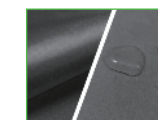

High quality waterproof material

Model	CSC-2
Size	118cm(diameter)
Outlet hose	2.8m

CSC-1 Split A/C Cleaning Cover

Full Protection, Easy Installation

- Made of artificial PU grade waterproof sealing strip with tight stitches
- Soft, sturdy, waterproof, corrosion resistant and durable
- The adjustable frame can change the length and suit for different split air conditioners
- Transparent front curtain can see coils' cleanliness clearly and prevents splashing
- 4 small back transparent films in the back of the A/C prevents walls from splashing

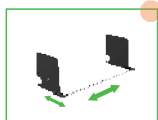

Adjustable frame



Transparent front curtain



Transparent back film

Model	CSC-1
Size	H:280*W:280*L700-1000(adjustable)
Outlet hose	5m

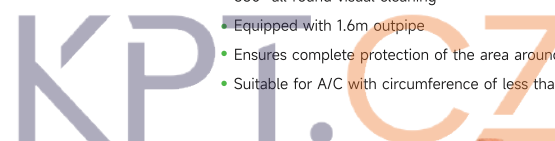

CSC-3S/3P Ceiling A/C Cleaning Cover

- 360° all-round visual cleaning
- Equipped with 1.6m outpipe
- Ensures complete protection of the area around the evaporator.
- Suitable for A/C with circumference of less than 2.5 meters

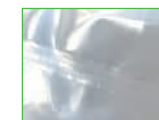

Double seal protection



Full surround design



One drainage pipe

Model	CSC-3S	CSC-3P
Size	2.5m(perimeter)	3.5m(perimeter)
Outlet hose	1.6m	1.6m



C2BW
Hand-holder
Electric Sprayer

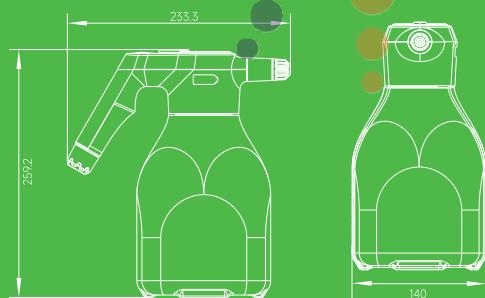

C2BW
Hand-holder
Electric Sprayer



Resistant of strong acids & alkaline

KLÍMA PRE TEBA.SK



HD LCD battery indicator clearly display of remaining power



Visual level display clearly show of remaining cleaner



High-speed micro-motor allows good working pressure



Universal usb charging port, makes the charging in anytime, anywhere

Product Description

The C2BW hand-holder electric sprayer is constructed of high density polyethylene, and all of the material can be resistant of strong acids & alkaline. Built-in a 3.7V/2200mAh Li-ion, so it is perfectly replace the current hand-holder manual sprayer.

The adjustable spray nozzle allows a complete range of spray patterns. So the C2BW hand-holder electric sprayer can be used for spraying solutions of most coil cleaners on air conditioning cooling coils, air-cooled condensers, finned heating coils, refrigeration case or cooler coils, permanent air filters and other greasy, dirty surfaces.

 Tank capacity
2L

 Li-ion Battery
3.7V/2200mAh

Technical Data

Model	C2BW
Voltage	3.7V(2200mAh)
Optimum Spray Distance	0.5-3m
Tank Capacity	2L
Nozzle Spray Sizes	0.3L/min(mist), 0.5L/min(water column)
Reference Running Time	2 hours
Reference Charging Time	2-3 hours
Packing	Carton:6pcs

Accessories

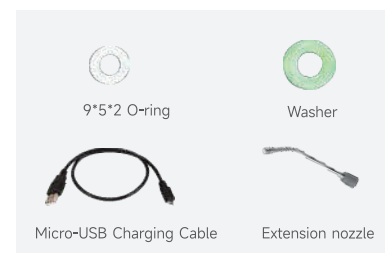



**CT370
Chiller
Tube Cleaner**

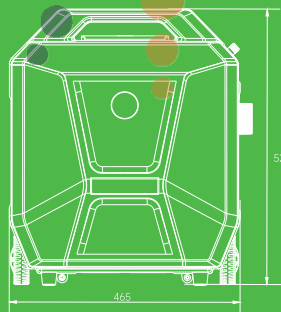
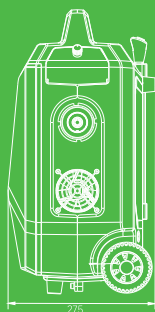

**CT370
Chiller Tube Cleaner**

Compact Design
Portable & Durable



Self-priming Function
Pump water from buckets or storage tanks



Integrated storage
A full set of brushes be storage in main body



Reliable&Durable
Forced air cooling,keep the long time of stable operation



Excellent mobility
Equiped with wheels and push handle



Patented Tech
Quick-connect structure make the brushes changes quickly and easily



Product Description

CT370 is a professional tool for Chiller tube cleaning, featured with rugged and dependable. Special for HVAC maintenance technicians and contractors.

This compact tube cleaner kit includes everything you need for better tube cleaning, plus all the innovative features you expect. Integrated flush, self priming function,860 RPM shaft rotation, quick connect shaft and brushes and all at half the size of our traditional tube cleaners.

The wheels and telescopic handle make it easy to transport between locations. An integrated storage compartment provides a handy location to keep all your accessories together in between uses, so they're always to hand when you need them, Bring you the ultimate experience in portability.

- Shaft Speed
860r/min(230V)
1000r/min(100-120V)
- Input Power
1/2HP

Technical Data

Model	CT370	
Voltage	100-120V~/50-60Hz	230V~/50-60Hz
Output Power	1/2HP	
Shaft Speed	1000r/min	860r/min
Shaft Length	7.6m	
Cord Length	4m	
Shaft Size	12mm(7.6m)	
Brushes	18pcs(2boxes)	
Weight	24kg	
Remarks	12mm shaft cover brushes from 1/2",9/16",5/8",11/16",3/4",13/16",7/8",15/16",1"	
Packing	Carton:1pcs	

Accessories



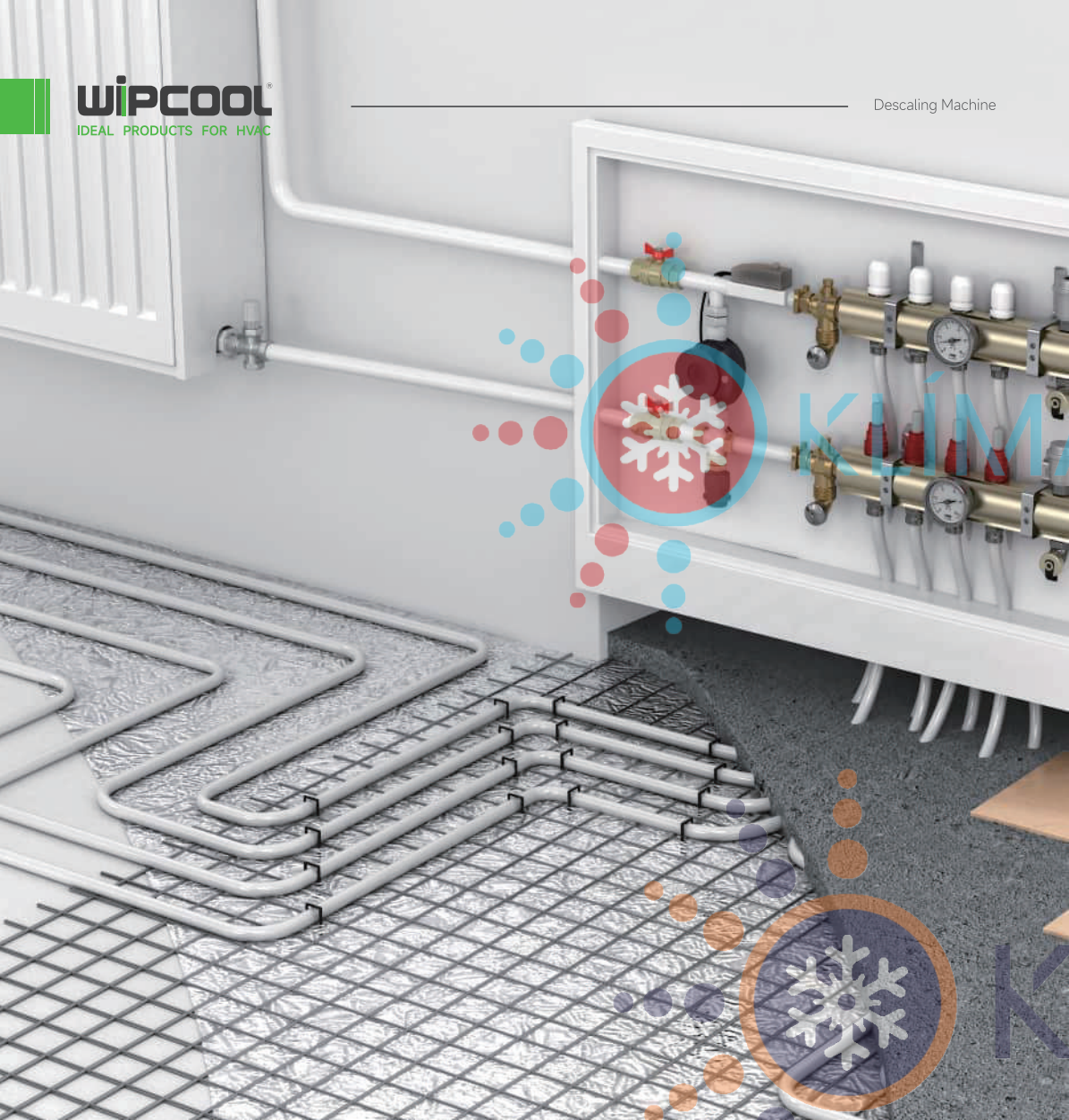

CDS24 Descaling Machine

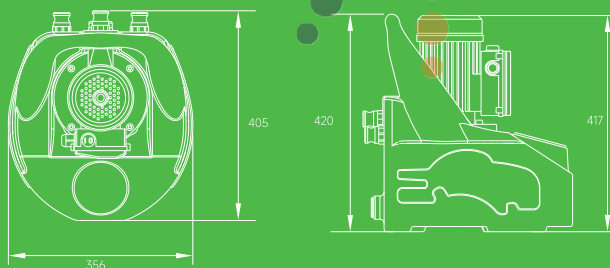

CDS24 Descaling Machine

Compact Design
Portable & Durable

KLÍMA PRE TEBA.SK



Compact design
Easy transport and storage



Vortex type flush
More stable, continuous and uninterrupted flush



Multiple purposes
Heat exchangers, water pipes, heating and cooling systems



Product Description

CDS24 is the best solution for whom need more portable yet still powerful descaling. Constructed of heavy-duty polyethylene and acid-proof components, these units are designed for years of use in industrial applications.

Each unit is self-priming and safely contains chemicals within its integral tank, allowing maximum user-friendliness. The CDS24 works great on small-size applications like oil coolers, plate and frame heat exchangers, water pipes, storage, heating and cooling systems and more.

 Max flow
33L/min

 Max discharge head
24m

 Tank capacity
15L

Technical Data

Model	CDS24
Voltage	230V~/50-60Hz or 100-120V~/50-60Hz
Output Power	1/2HP
Flow Rate	33L/min
Discharge Head	24m
Tank capacity	15L
Dimensions	420*356*405
Weight	11.5kg
Packing	Carton:1pcs

Accessories



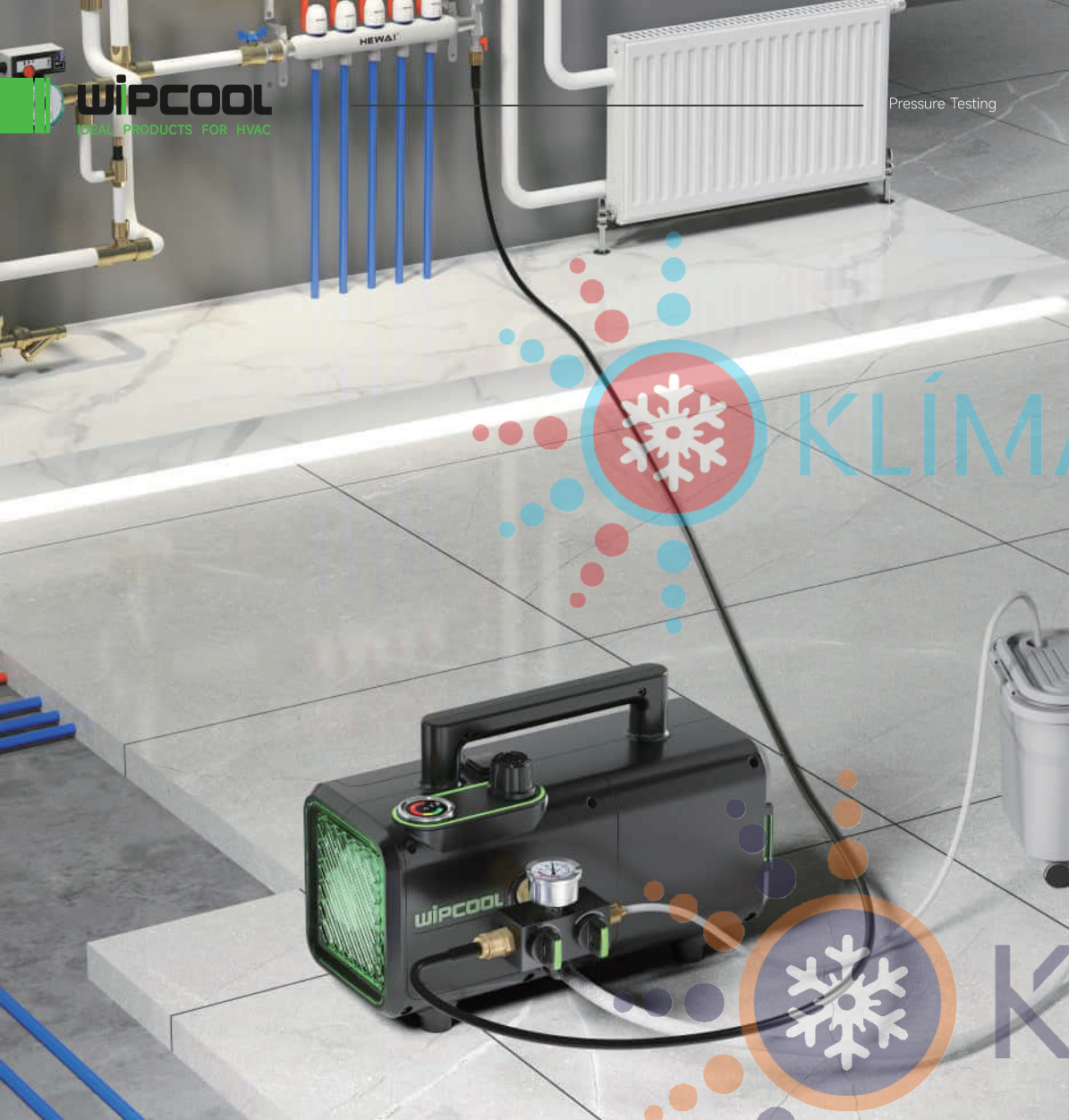

TV-15 Pressure Testing Valve

Professional
Fast & Efficient

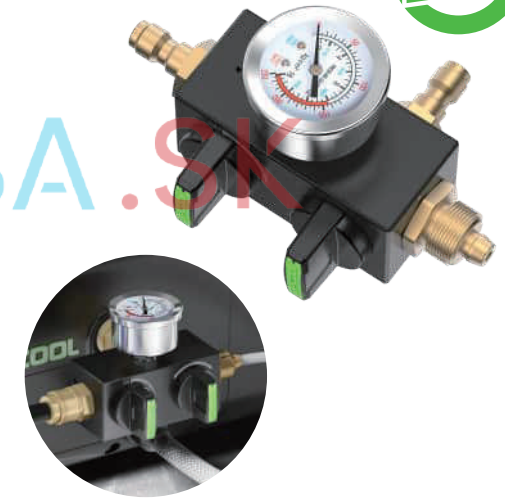

TV-15 Tube Pressure Testing Valve

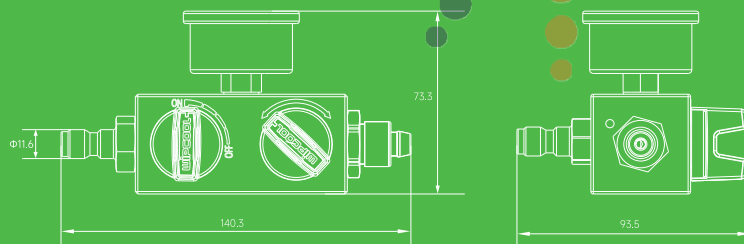

Product Description

The TV-15 Tube Pressure Testing Valve tests hydraulically for leaks in installations that are required to be leak proof and will test systems up to 15bar. Perfect for use in heating, compressed air, refrigeration systems, sprinkler systems and other small bore pipe installations.

Different from the traditional manual & electric pressure testing pumps, the TV-15 supplied the most economical solution. It can fit on WIPCOOL high pressure cleaning machines(C28T, 28B, C40T), but also fit all of high pressure cleaning machines on the market(1/4" fittings). So once you had a cleaning machine in hand, just buy a TV-15 for extending a new function.

In additional, quick coupling system to disconnect the testing valve fast. This can be left on circuit being tested. Cleaning machine can be used to pressurize another circuit with second testing valve.

 Maximum water flow
5 L/min

 15 bar
Max testing pressure

Technical Data

Model	TV-15
Pressure Testing(Max.)	15bar
Water Flow	5L/min
Coupling Fitting	1/4"
Suitable For	C28T,C28B,C40T

Accessories



Sealing Cover

Refrigerant Oil Charging Pump

Where the refrigerant is essential for the cooling properties of a refrigeration system, the refrigeration oil is crucial for the correct functioning of the compressor. It mainly plays four roles: lubrication, sealing, cooling and energy regulation.

1, Lubrication

Lubricants for refrigeration compressors reduce friction and prevent wear, so as to extend the service life of the compressor.

2, Sealing

The refrigeration oil plays a sealing role in the compressor, which makes the piston and cylinder face in the compressor and the rotating bearings achieve the sealing effect, so as to prevent the refrigerant leakage.

3, Cooling

The refrigeration oil can take away the heat generated in the working process and keep the moving parts of the compressor at a lower temperature, so as to improve the efficiency and reliability of the compressor.

4, Energy regulation

For the compressor with energy regulating mechanism, the oil pressure of refrigeration oil can be used as the power of energy regulating mechanism.

So the correct use and timely replacement of refrigerate oil will have a great impact on the service life and refrigeration effect of the compressor.

The WPCOOL "Robust series" oil charging pump is developed for widely types of refrigeration compressor, represented by the electric oil charging pump series, which solves the charging problem of large flow under large back pressure, saves labor and improves efficiency. At the same time, Considering the high viscosity of refrigeration oil in winter, We firstly developed an unlimited electric charging series for all kinds refrigeration oil in Worldwide.



How To Choose A Oil Charging Pump

Following points should be considered when you choose a refrigeration oil charging pump

1, System's back pressure

When the system is under back pressure, the greater of back pressure that the oil pump can overcome, the more time and effort will be saved when charging. Therefore, the maximum back pressure that can be overcome must be considered when selecting an oil charging pump.

2, Flow Rate

The flow rate of a oil charging pump is usually expressed in liters/hour, so the time to charge is directly related to the flow rate. Therefore, it is necessary to select a suitable pump according to the amount of oil marked on the compressor and how many units need to charge.

3, Viscosity

Viscosity is a main performance index of refrigeration oil. Different refrigerants have different requirements for viscosity. At the same time, the viscosity of the refrigerating oil changes greatly with the temperature. The lower the temperature, the greater the viscosity. Therefore, the characteristics of the added refrigeration oil and the ambient temperature must be fully considered when selecting the oil charging pump.

Oil Charging Pump Selection Guide

Model	Max overcome pressure	Flow Rate	Viscosity
R1	10bar(145psi)	50ml/stoke	68
R2	15bar(218psi)	75ml/stoke	68
R4	16bar(232psi)	150L/h	100
R6	25bar(362psi)	350L/h	100

Unit Label			
Model	XXXXXXXXXX		
Cooling capacity	454kW	Voltage	3PHASE,380V,50Hz
Power Input	84.9kW	Running current	154A
Power factor	87%	Comp output	2X45kW
Refrigerant	R134a /140kg	Design press(Hi/Lo)	H1.59/L0.87Mpa
Ref oil	FVC68D/22L	Air tight test press(Hi/Lo)	H1.59/L0.87Mpa
MFG No.	XXXX	Unit weight	3650kg
Production license No.	XXXXXXXXXX		

Remarks: If it is a new unit or an overhauled unit, the oil filling amount is indicated on the unit nameplate. If it is just change oil, follow the principle of charging as much as it is released.

Refrigeration Oil's Selection (For reference only)

Viscosity	Domestic air conditioning unit (Compressor)			Commercial central air conditioning, industrial refrigeration equipment(Compressor)		
	Piston	Rotary	Centrifugal	Piston	Screw	Scroll
32	√	√	√	√		
46	√	√	√	√		
68		√	√	√	√	√
100			√		√	√



R1 Manual Refrigeration Oil Charging Pump

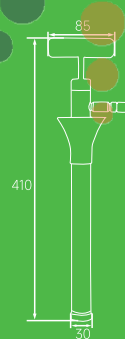

R1 Manual Refrigeration Oil Charging Pump

Pressurized Charging,
Reliable And Durable



Applied stainless steel materials, reliable and durable



Anti-backflow structure, ensure system safety during charging



Special design, ensure to connect the different size of oil bottles



Pumps oil into the system without shutting down for charging



Product Description

R1 Refrigeration Oil hand charging Pump provides for the addition or removal of refrigeration oil when servicing air conditioning and refrigeration systems.

The pump can be used while the unit is operating. It is not necessary to shut down the system for charging. Can be used on one gallon, two and a half gallon and five gallon containers. Moves 1.7 fl. oz. (50ml) per stroke against 145 psi(10bar) pressure.

Flow rate
50ml per stroke

Maximum overcoming
back pressure 10bar

Technical Data

Model	R1
Max. Pump To Against Pressure	10bar (145psi)
Max. Pump Rate Per Stroke	50ml
Applicable Oil Bottle Size	All sizes
Hose Connect	1/4" SAE
Outlet hose	1.5m Charging Hose
Packing	Blister/Carton:10pcs

Accessories



1.5m transparent
charging hose



R2 Manual Refrigeration Oil Charging Pump

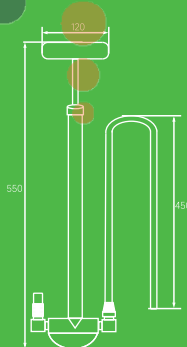

R2 Manual Refrigeration Oil Charging Pump

Pressurized Charging,
Reliable And Durable



Applied stainless steel materials, reliable and durable



Anti-backflow structure, ensure system safety during charging



Special design, ensure to connect the different size of oil bottles



Pumps oil into the system without shutting down for charging

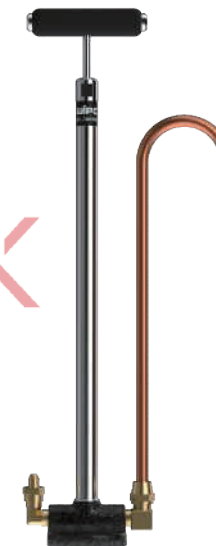

Product Description

The R2 oil charging pump is designed and manufactured to allow technicians to pump oil into the system while the unit is operating. There is no need to shut down the system for charging.

Features a universal stopper that automatically adjusts to all standard openings in 1, 2-1/2 and 5 gallon oil containers. Suction transfer hose and fittings included. It allows you to pump oil into the compressor on the down stroke while the system is under pressure, making pumping easier with a positive stroke.

Flow rate
75ml per stroke

Maximum overcoming
back pressure 15bar

Technical Data

Model	R2
Max. Pump To Against Pressure	15bar (218psi)
Max. Pump Rate Per Stroke	75ml
Applicable Oil Bottle Size	All sizes
Hose Connect	1/4" & 3/8" SAE
Outlet hose	1.5m HP Charging Hose
Packing	Carton box/Carton:6pcs

Accessories



1.5m high-pressure
charging hose



R4 Electric Refrigeration Oil Charging Pump

Portable & Powerful



Strong power, easy charging under large system's back pressure.



Built-in boost valve which can make the instant pressurization.



High precision gear pump with self-priming, ensure easy charging.



Built-in thermal protection device, effectively prevent overloading.

R4 Electric Refrigeration Oil Charging Pump

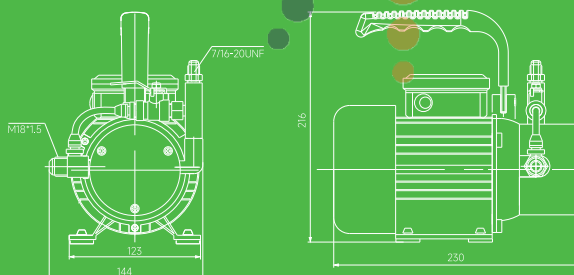

Product Features

R4 is a portable refrigeration oil transfer pump which is ideal for charging compressor oil into large HVAC systems. With a 1/3 HP electric motor directly coupled to a fixed-displacement gear pump, oil can be pumped into your system even while in operation.

Max flow
150L/h

Built-in thermal-overload protector for effectively preventing overloaded and a ball-type check valve is installed inside of the pump to prevent oil or refrigerant from flowing back in case of a power failure or breakdown. Keep the system in safety situation.

Max overcoming
back pressure
16bar

Technical Data

Model	R4
Voltage	230V~/50-60Hz or 100-120V~/50-60Hz
Motor Power	1/3HP
Pump to Against Pressure(Max.)	16bar (232psi)
Flow Rate(Max.)	150L/h
Hose Connect	1/4" & 3/8" SAE
Packing	Carton:2pcs

Accessories





R6 Electric Refrigeration Oil Charging Pump

Strong Power, Easy Charging



Strong power, easy charging under large system's back pressure.



Overhead pressure gauge, easy to read the exact operation pressure.



High precision and high displacement gear pump, ensure easy charging.



Built-in thermal protection device, effectively prevent overloading.

Product Features

R6 is a heavy-duty refrigeration oil transfer pump which is ideal for charging compressor oil into large HVAC systems. With a 3/4 HP electric motor directly coupled to a high displacement gear pump, the different viscosity oil (even the high viscosity in low temperature) can be pumped into your system even while in operation.

Built-in thermal-overload protector for effectively preventing overloaded and a ball-type check valve is installed inside of the pump to prevent oil or refrigerant from flowing back in case of a power failure or breakdown. Keep the system in safety situation.

In addition, a overhead pressure gauge installed to make the easy reading the exact operation pressure. So R6 is a ultimate solution for refrigeration oil charging.

 Max flow
350L/h

 Max overcoming
back pressure
25bar

Technical Data

Model	R6
Voltage	230V-/50-60Hz or 100-120V-/50-60Hz
Motor Power	3/4HP
Pump to Against Pressure(Max.)	25bar (362psi)
Flow Rate(Max.)	350L/h
Hose Connect	1/4" & 3/8" SAE
Packing	Carton:1pcs

Accessories



R6 Electric Refrigeration Oil Charging Pump

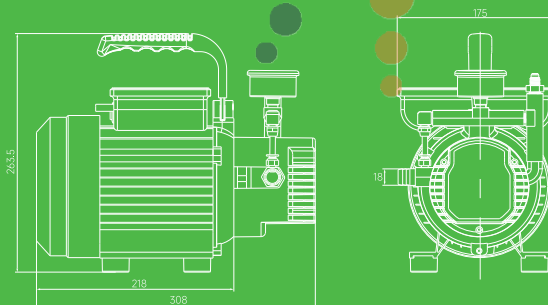



KLÍMA PRE TEBA.SK



KP.T.CZ

HVAC/R Tools & Equipment

Due to years of deep technical accumulation of refrigeration tools & equipment and unceasing exploration of high technologies, and the initial intention of " helping HVAC service technicians to complete air-conditioning service work efficient, WIPCOOL has launched highly differentiation products.

Our products covered recovery & vacuum machines, refrigeration tools, tubing tools, measuring & testing tools.

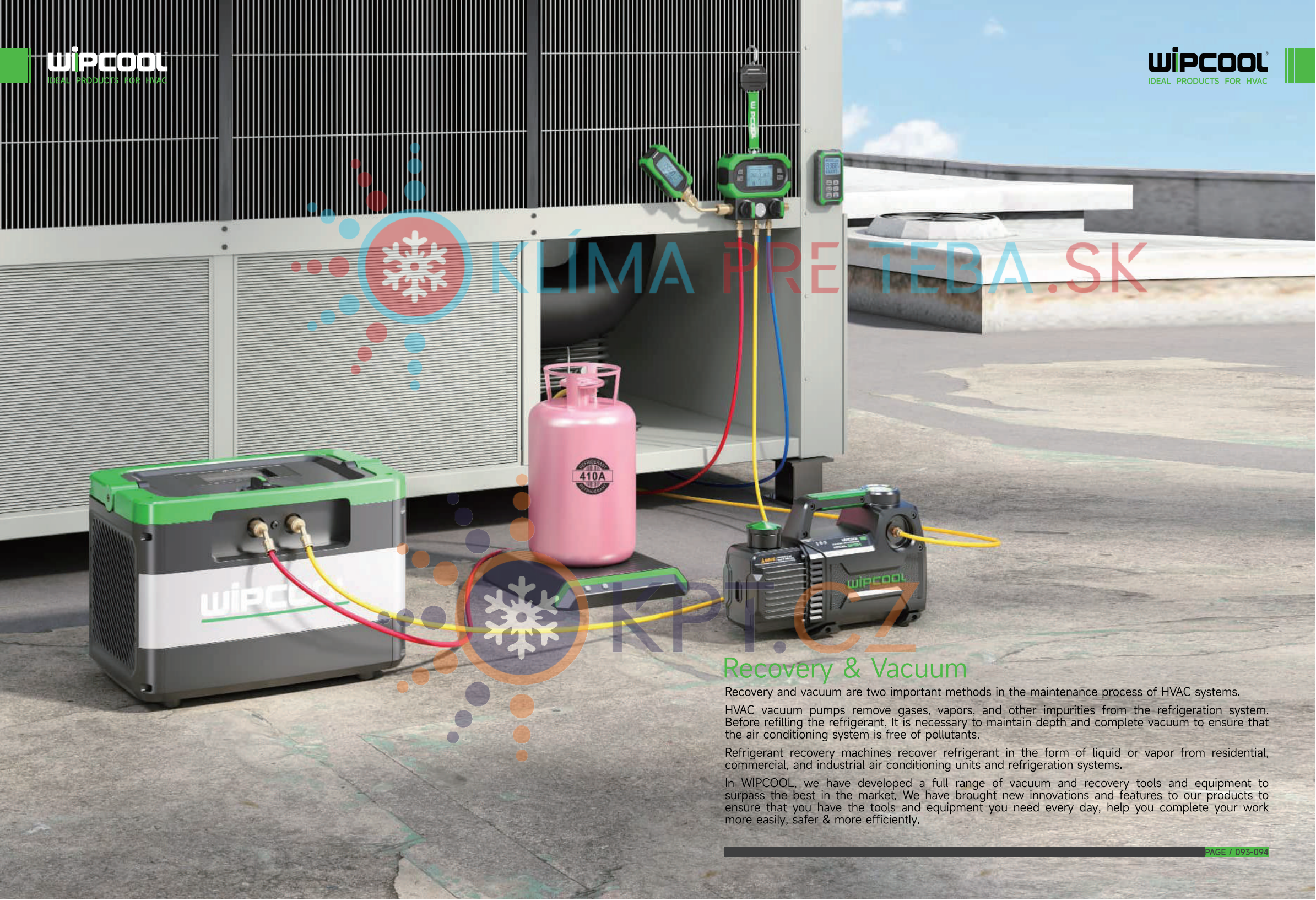

KLÍMA PRE TEBA.SK



KPI.CZ

Recovery & Vacuum

Recovery and vacuum are two important methods in the maintenance process of HVAC systems.

HVAC vacuum pumps remove gases, vapors, and other impurities from the refrigeration system. Before refilling the refrigerant, it is necessary to maintain depth and complete vacuum to ensure that the air conditioning system is free of pollutants.

Refrigerant recovery machines recover refrigerant in the form of liquid or vapor from residential, commercial, and industrial air conditioning units and refrigeration systems.

In WIPCOOL, we have developed a full range of vacuum and recovery tools and equipment to surpass the best in the market. We have brought new innovations and features to our products to ensure that you have the tools and equipment you need every day, help you complete your work more easily, safer & more efficiently.

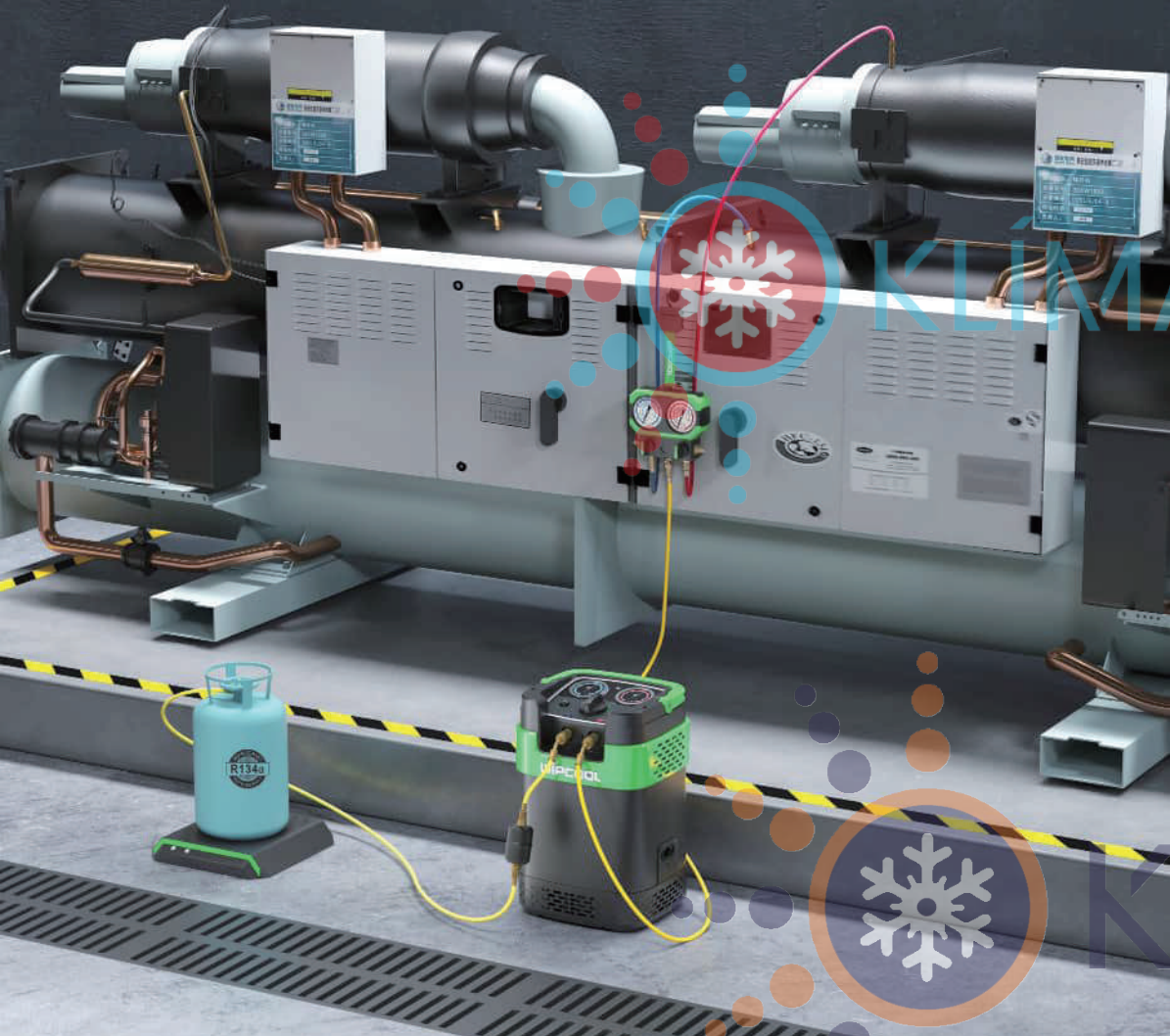

Single Piston Refrigerant Recovery Machine

Product Description

The MRM55 is a lightweight, efficient, and reliable refrigerant recovery machine with a compact, sturdy casing. It provides an ideal solution for making refrigerant recovery fast and simple.

Different from most brands of refrigerant recovery machines, it adopts an integrated vertical structure design, with a overhead pressure gauge and operating key design. In addition, there has a service port at the back of the machine, so it will be very convenient to replace the piston ring and air valve core. Bringing a more user-friendly user experience.

At the same time, this recovery machine can cover A2L grade refrigerants and backward compatible with these older refrigerants (such as R12, R22, and R410A).

MRM55 Refrigerant Recovery Machine

Lightweight, Efficient & Reliable



Built-in oil separator (MRM55OS)



Vertical structure design based on ergonomic experience



Overhead pressure gauge for easy reading the exact data



A easy access port at the back of machine for fast maintenance

Model	MRM55 / MRM55OS					
Refrigerant	III: R12, R134A, R401C, R406A, R500, R1234yf	Automatic Safety Shut-off		38.5bar/3850kpa(558psi)		
	IV: R22, R401A, R401B, R402B, R407C, R407D, R408A, R409A, R411A, R411B, R412A, R502, R509	Recovery Rate	III	IV	V	
	V: R402A, R404A, R407A, R407B, R410A, R507, R32		Vapor	0.22 kg/min	0.25 kg/min	0.25 kg/min
Voltage	110V~/60Hz	230V~/50-60Hz	Liquid	1.8 kg/min	2.0 kg/min	2.2 kg/min
Motor Power	3/4HP		Push/Pull	5.0 kg/min	6.0 kg/min	6.5 kg/min
Motor Speed	2300RPM		Operating Temperature	0°C-40°C		
Current(Max.)	8A	4A	Dimensions	259mm(L)*235mm(W)*390mm(H)		
Compressor	Oil-less, Air-cooled, Piston-style		Weight	9.5 kg		
			Packing	Carton:1pc		

Accessories



1.8m power cord



Filter



Shoulder Strap



Hose

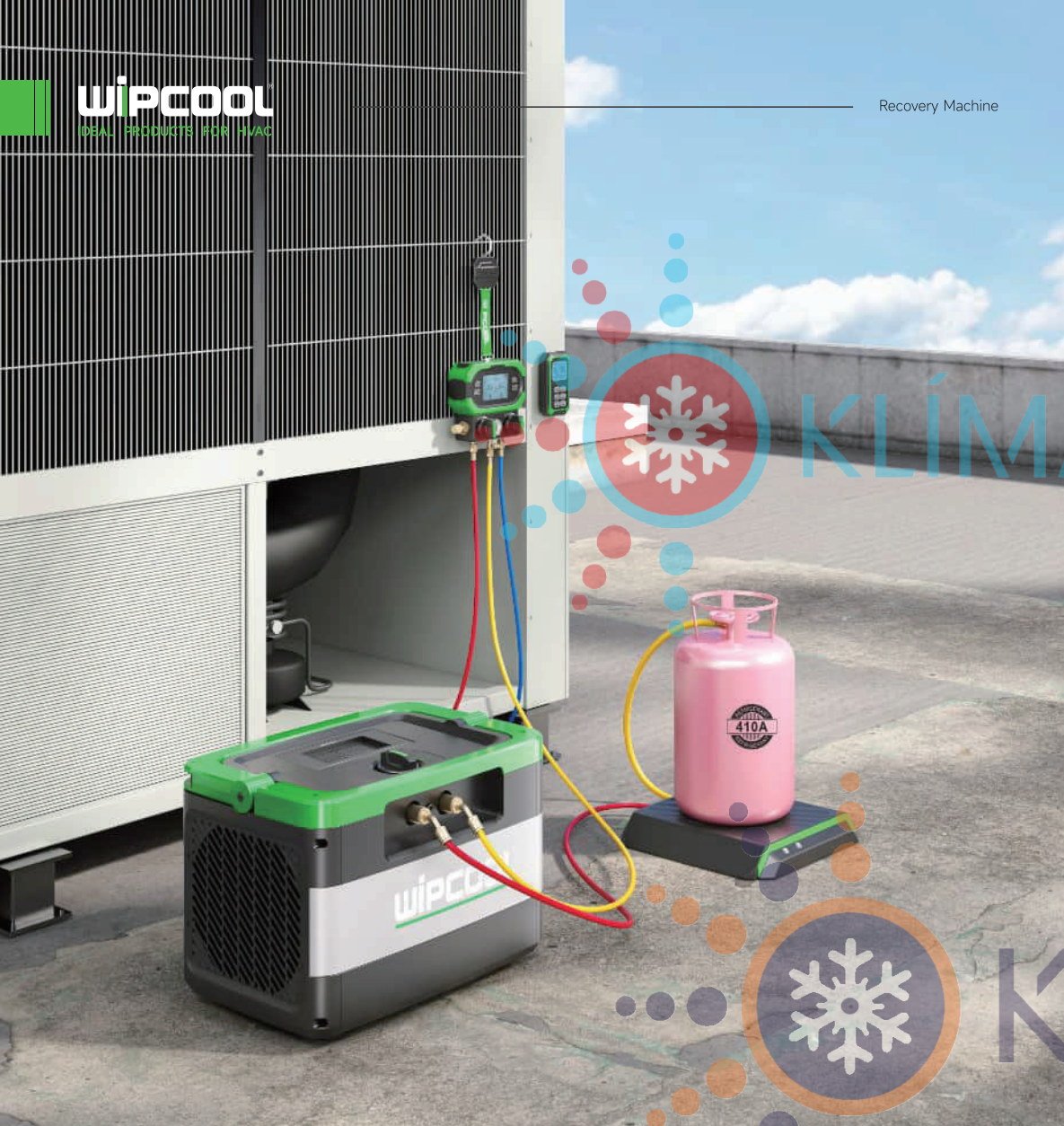

Dual Pistons Refrigerant Recovery Machine

Product Description

The MRM75 is an efficient, and reliable refrigerant recovery machine with a compact, sturdy casing. Dual pistons provides an ideal solution for making refrigerant recovery fast and efficient.

Different from most brands of refrigerant recovery machines, it adopts overhead pressure gauge and operating key design. In addition, there has a service port at the back of the machine, so it will be very convenient to replace the piston ring and air valve core. Bringing a more user-friendly user experience.

At the same time, this recovery machine can cover A2L grade refrigerants and backward compatible with these older refrigerants (such as R12, R22, and R410A).

MRM75 Refrigerant Recovery Machine

Fast Recovery, Efficient & Reliable

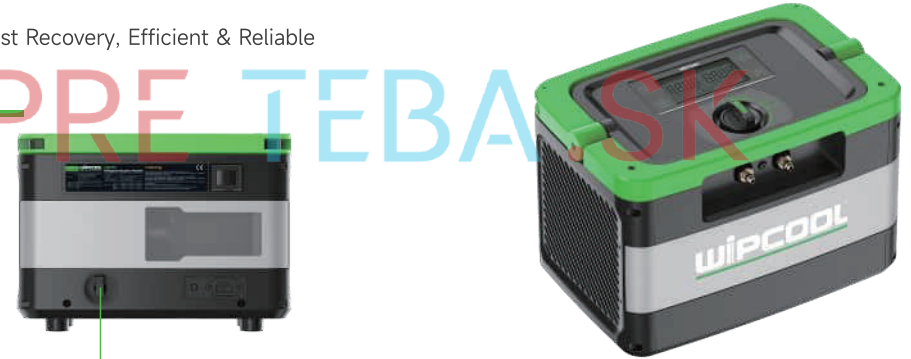

Built-in oil separator (MRM75OS)



Oil-free compressor with high efficient



Overhead digital display for easy reading the exact data



A easy access port at the back of machine for fast maintenance

Model	MRM75 / MRM75OS				
Refrigerant	III: R12, R134A, R401C, R406A, R500, R1234yf	Automatic Safety Shut-off		38.5bar/3850kpa(558psi)	
	IV: R22, R401A, R401B, R402B, R407C, R407D, R408A, R409A, R411A, R411B, R412A, R502, R509	III	IV	V	
	V: R402A, R404A, R407A, R407B, R410A, R507, R32	Vapor	0.5 kg/min	0.7 kg/min	0.7 kg/min
Voltage	110V~/60Hz	Recovery Rate		Liquid 2.6 kg/min 3 kg/min 3.9 kg/min	
	230V~/50-60Hz	Push/Pull	8.2 kg/min	9.3 kg/min	10.5 kg/min
Motor Power	1.3HP		Operating Temperature		0°C-40°C
Motor Speed	3000RPM		Dimensions		386mm(L)*255mm(W)*276mm(H)
Current(Max.)	6.5A	13A	Weight		11.6 kg
Compressor	Oil-less, Air-cooled, Piston-style		Packing		

Accessories



1.8m power cord



Filter



Shoulder Strap



Hose

S Series Vacuum pump

Compact & Portable



Product Features



Anti-dumping oil leakage



Anti-oil injection design



High-precision rotary vane pump



DC motor technology

Technical Data

Model	S1	S1.5	S2
Voltage	230V~/50-60Hz or 100-120V~/50-60Hz		
Ultimate Vacuum	150 microns		
Input Power	1/4HP	1/4HP	1/3HP
Flow Rate (Max.)	2CFM 57L/min	3CFM 85 L/min	4CFM 113 L/min
Oil Capacity	230ml	210ml	200ml
Dimension	266x121x194		
Inlet Port	1/4" SAE		
Packing	Carton:3pcs		

S Series Vacuum pump

Product Description

The S Series of vacuum pumps are a great range when price is a major consideration. Available in a wide range of capacities. And flow rate cover from 2-4CFM(57-113LPM),so they are ideal for split systems, light duties in automotive and small commercial applications.

Features a full clear oil reservoir to give you an instant indicator of the condition of your oil and system. And the reservoir applied customized special engineering plastic ABS for durable usage, troubleshoot problems quickly and easy to repair or replace the parts.



F Series R410A Vacuum Pump

Product Description

Refrigerant R410 is a new type of environmentally friendly refrigerant, which does not destroy the ozone layer. So it is widely used in domestic and commercial air conditioner.

Since the R410A is different from other refrigerants used before, like R12, R22 ect, it is easily affected by impurities such as moisture, oxide layer, grease, etc. Therefore, full attention should be paid during construction and operation, and clean hose should be used to prevent the mixing of water and other substances. Deep vacuum should be done to prevent the air in the system will react with the refrigerating oil and affect the properties of the refrigerating oil. In addition, a solenoid valve should be used to prevent vacuum pump back flow into system.

The F series of vacuum pump are a better choice when good using experience is a major consideration. It equipped with built-in solenoid valve and overhead vacuum meter as standard. Since oil leakage is a matter if the pump was side down during your working or driving, So our pump's biggest feature is to avoid this risk of oil leakage. And the overhead vacuum meter design also bring you a new using experience to avoid you lean down to read the exact vacuum data.

In addition, reinforced aluminum alloy oil tank, effective heat dissipation, resistance to chemical corrosion, Oil color and level are easy to see with the oversized sight glass. The powerful and lightweight DC motor delivery a great starting moment is easy for starting and high efficiency, which can keep it working perfectly even in lower ambient temperature.

F Series R410A Vacuum Pump

Vacuumping Quickly



Product Features



Anti-dumping oil leakage



Overhead vacuum gauge



Built-in solenoid valve

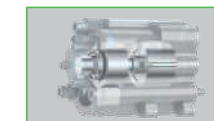

High-precision rotary vane pump

Technical Data

Model	F1	F1.5	2F0	2F1
Voltage	230V~/50-60Hz or 100-120V~/50-60Hz			
Ultimate Vacuum	150 microns		15 microns	
Input Power	1/4HP	1/4HP	1/4HP	1/4HP
Flow Rate (Max.)	1.5CFM 42 L/min	3CFM 85 L/min	1.5CFM 42 L/min	2.5CFM 71 L/min
Oil Capacity	200ml	330ml	280ml	280ml
Dimension	289x113x198		309x113x198	
Inlet Port	1/4"SAE			
Packing	Carton:3pcs			

F Series R32 Vacuum Pump

Light Weight, Fast Vacuuming



Product Features



Anti-dumping oil leakage



Overhead vacuum gauge



Built-in solenoid valve



DC brush-less motor

Technical Data

Model	2F0R	2F1R	2F1.5R	F2R	2F2R	F3R	2F3R	F4R	2F4R	F5R	2F5R
Voltage	230V~/50-60Hz or 100-120V~/50-60Hz										
Ultimate Vacuum	15microns		150microns		15microns	150microns	15microns	150microns	15microns	150microns	15microns
Input Power	1/4HP	1/4HP	1/3HP	1/3HP	1/2HP	1/2HP	3/4HP	3/4HP	1HP	1HP	1HP
Flow Rate (Max.)	1.5CFM 42 L/min	2.5CFM 71 L/min	3CFM 85 L/min	5CFM 142L/min	5CFM 142L/min	7CFM 198 L/min	7CFM 198 L/min	9CFM 255L/min	9CFM 255L/min	11CFM 312L/min	11CFM 312L/min
Oil Capacity	280ml	280ml	480ml	580ml	450ml	560ml	520ml	690ml	500ml	670ml	480ml
Dimension	309x113x198			339x130x225			365x147x242				
Inlet Port	1/4"SAE			1/4" & 3/8 SAE			1/4" & 3/8"SAE				
Packing	Carton:3pcs			Carton:3pcs			Carton:2pcs				

F Series R32 Vacuum Pump

Product Description

R-32 is a next generation refrigerant that efficiently carries heat and has lower environmental impact. It can reduce electricity consumption up to approximately 10% compared to that of air conditioners using refrigerant R-22. Furthermore, compared to the refrigerants widely used today such as R-22 and R-410A, R-32 has a global warming potential (GWP) that is 1/3 lower and is remarkable for its low environmental impact. So all large manufacturers are promoting it as the new refrigerant in the market.

Due to the flammability and high operating pressures of R32, existing equipment (e.g. manifolds, gauges, vacuum pumps, recovery units) must be checked for compatibility. Any potential sources of ignition from electrical equipment must be eliminated.

F series of R32 vacuum pump is special design for this new generation refrigerant, it can be uses with (A2L or A2) flammable refrigerants and backward compatible with old refrigerant (such as R12,R22 and R410A etc). Equipped with built-in solenoid valve and overhead vacuum meter as standard. In addition, reinforced aluminum alloy oil tank, effective heat dissipation, resistance to chemical corrosion, Oil color and level are easy to see with the oversized sight glass. The powerful and lightweight brush-less DC motor delivery a great starting moment is easy for starting and high efficiency with long service life, which can keep it working perfectly even in lower ambient temperature.



F Series Cordless Vacuum Pump

Product Description

F series of Cordless Vacuum Pump eliminates the hassle of cords and provides instant power for fast evacuations. Powered by 18V Li-ion battery, they can deliver the runtime to complete multiple jobs on one charge. Enabling up to 45-60 minutes of runtime per charge(4.0Ah).

There has 3 flow rate(1.5/2.5/5 CFM) and compatible with the new generation refrigerant(A2L) for your choice. Equipped with built-in solenoid valve and overhead vacuum meter as standard.

In addition, reinforced aluminum alloy oil tank, effective heat dissipation, resistance to chemical corrosion. Oil color and level are easy to see with the oversized sight glass.

Further more, in order to maximize the utilization of existing Li-ion batteries in users' hands and reduce their purchasing costs, we have specially developed 6 mainstream brand battery adapters (Bosch, Makita, Panasonic, Dewalt, Worx, and Devon), which can easily be compatible with the use of the above brand batteries

F Series Cordless Vacuum Pump



Li-ion Battery Power, Portable Evacuation



BC-18P, See P102
Applied on
F2BR, 2F2BR
Available separately



BC-18, See P102
Applied on
F1B, 2F0B/2F0BR, 2F1B/2F1BR
Available separately



Milwaukee DeWalt Worx Bosch Makita Panasonic
Battery Adapter, See P102
Available separately

Product Features



Li-ion battery powered



Anti-dumping oil leakage



Overhead vacuum gauge

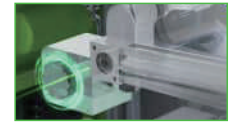

Built-in solenoid valve

Technical Data

Model	F1B	2F0B	2F0BR	2F1B	2F1BR	F2BR	2F2BR
Voltage	DC18V(AEG/ RIDGID interface)						
Ultimate Vacuum	150microns	15microns	15microns	15microns	15microns	150microns	15microns
Input Power	1/4HP	1/4HP	1/4HP	1/4HP	1/4HP	1/3HP	1/2HP
Flow Rate (Max.)	1.5CFM 42 L/min	1.5CFM 42 L/min	1.5CFM 42 L/min	2.5CFM 71 L/min	2.5CFM 71 L/min	5CFM 142 L/min	5CFM 142 L/min
Oil Capacity	200ml	280ml	280ml	280ml	280ml	580ml	450ml
Dimension	289x113x198		309x113x198			339x130x225	
Reference running time			45mins(4.0AhLi-ion battery)			40mins(4.0AhLi-ion battery)	
Reference charging time			210mins(4.0AhLi-ion battery)			210mins(4.0AhLi-ion battery)	
Remarks	Due to the strict transportation terms, we can not include any Li-ion battery, you can choose our battery adapters for use your local batteries.						
Packing							Carton:3pcs

F Series Dual Powered Vacuum Pump (Li-ion & AC powered)

Dual Powered, Freely Switch



Never suffer from low battery anxiety



Freely switch between AC power and battery power



Avoiding any downtime on the jobsite



Product Description

The F series of dual power vacuum pump is based on cordless vacuum pump and can be freely switched between 18V Li-ion batteries and 220V AC power. It can enable up to 45-60 minutes of operation time when using a 18V/4.0Ah capacity Li-ion battery, solving the problem of finding AC power supply for outdoor enaction. If AC power is relatively easy to obtain, it can provide long-term operation to avoid the anxiety of Li-ion battery depletion in a short time.

There has 3 flow rate(1.5/2.5/5 CFM) and compatible with the new generation refrigerant(A2L) for your choice. Equipped with built-in solenoid valve and overhead vacuum meter as standard. In addition, reinforced aluminum alloy oil tank, effective heat dissipation, resistance to chemical corrosion. Oil color and level are easy to see with the oversized sight glass.

Further more, in order to maximize the utilization of existing Li-ion batteries in users' hands and reduce their purchasing costs, we have specially developed 6 mainstream brand battery adapters (Bosch, Makita, Panasonic, Dewalt, Worx, and Devoni), which can easily be compatible with the use of the above brand batteries.

Model	F1BK	2F1BRK	F2BRK	2F2BRK
Voltage	18V(AEG/RIDGID) interface 230V~/50-60Hz or 100-120V~/50-60Hz			
Flow Rate(Max.)	1.5CFM 42 L/min	2.5CFM 71 L/min	5CFM 142 L/min	5CFM 142 L/min
Ultimate Vacuum	150microns	15microns	150microns	15microns
Include:	Tool box, Vacuum pump, Battery Adapter(2 free from the 6 adapters), Battery converter			
Reference running time	45mins(4.0AhLi-ion battery)		40mins(4.0AhLi-ion battery)	
Reference charging time	210mins(4.0AhLi-ion battery)		210mins(4.0AhLi-ion battery)	
Remarks	Due to the strict transportation terms, we can not include any Li-ion battery, you can choose our battery adapters for use your local batteries.			

AC Power Supply Plugs



Model	Description
W01	Israel plug
W02	China plug
W03	Australia plug
W04	South africa plug
W05	Europe plug
W06	America plug
W07	Britain plug
W08	Japan plug
W09	Italy plug
W10	Argentina plug
W11	Brazil plug
W12	South Korea Plug

F series

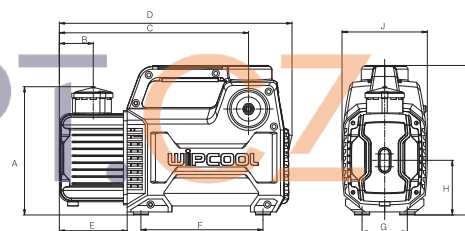

S series

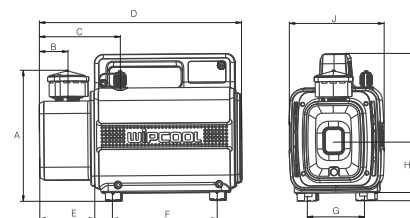

Size Table

Model	A	B	C	D	E	F	G	H	I	J
S1 S1.5 S2	145	36	107	266	73	138	70	69	194	121
F1.5 2F0(R) 2F1(R)	175	45	250	309	90	162	60	73	200	115
F2R F3R 2F1.5R 2F2R	195	45	280	339	110	165	70	87	225	130
F4R F5R 2F3R 2F4R 2F5R	211	50	300	365	115	190	70	97	242	147

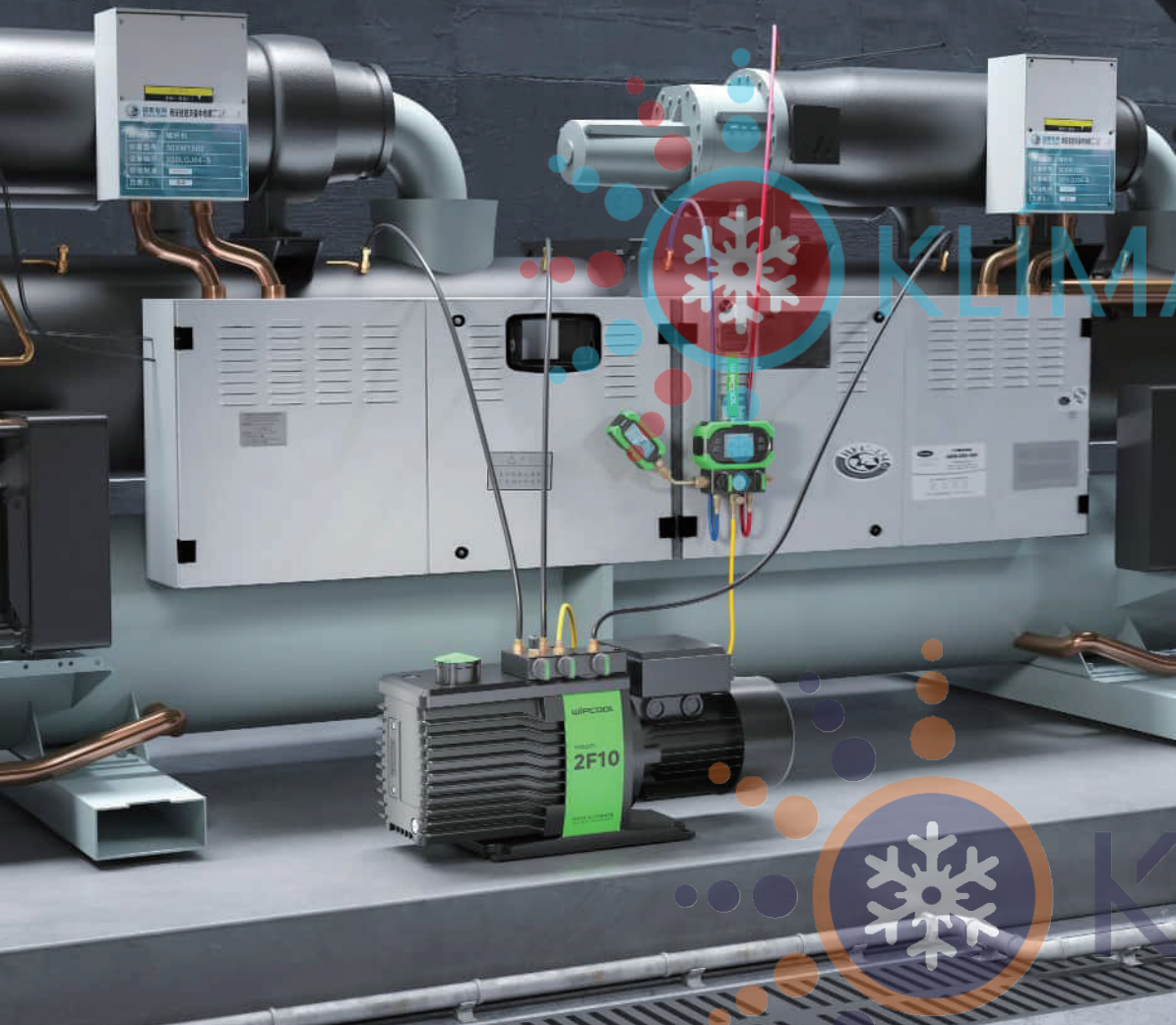

Industrial Vacuum Pump

Product Description

2F10 oil sealed rotary vane pumps are renowned for achieving high ultimate vacuum and rapid pumping speeds with quiet operation and the ability to handle vapour. This has become the industry standard in a range of scientific, laboratory, and light industrial applications, and are the ideal partner for install or repair these big HVAC systems, including ammonia systems.



2F10 Industrial Vacuum Pump

High Ultimate Vacuum
Reliable & Stable



Product Features



Easy to maintain
Sight glass makes visual inspection of the oil level and conditions simple



Gas ballast valve
Used when pumping vapour



Fast evacuation
5 way connections with 3*3/8"SAE & 2*1/4"SAE



Reliable performance
Overheating protection is provided via a thermal overload device which is fitted in the motor

Technical Data

Model	2F10	
Voltage	230V~/50-60Hz	
Peak pumping speed	50Hz	10L/S(36m ³ /h)
	60Hz	12L/S(43m ³ /h)
Ultimate Pressure w/o gas ballast	4 microns	
Ultimate Pressure with gas ballast	8 microns	
Motor power	1.5HP	
Rotate Speed(rmp)	1420@50Hz/1700@60Hz	
Operating Ambient Temperature	8-40°C	
Weight	≈40kgs	
Accessories	Trolley	

Vacuum Pump Oil

Perfect Maintenance



Model	WPO-1	WPO-2	WPO-3(For 2F10 Only)
Kinematic Viscosity(40°C)	41.4-50.6mm ² /s	41.4-50.6mm ² /s	90-110mm ² /s
Viscosity Index	100	100	105
Flash Point	225°C	225°C	268°C
Pour Point	-10°C	-10°C	-16°C
Oil Type	Mineral Oil	Mineral Oil	Mineral Oil
Capacity	500ml	1L	1L
Packing	Carton:18pcs	Carton:16pcs	Carton:16pcs

TB-1 TB-2 Tool box

Professional & Heavy duty



Model	TB-1	TB-2
Material	PP	PP
Interior dimensions	L450×W250×H220mm	L500×W320×H270mm
Thickness	3.5mm	3.5mm
Weight(empty)	2.2 kg	3.0 kg
Waterproof	Yes	Yes
Dustproof	Yes	Yes
Packing	Carton:6pcs	Carton:4pcs

BC-18 BC-18P Corded Battery Converter

Corded Power, Unlimited Running



Mode	BC-18	BC-18P
Input	100-240V~/50-60Hz	220-240V~/50-60Hz
Output	18V	18V
Power(Max)	150W	200W
Cord Length	1.5m	1.5m

BA-1~BA-6 Battery Adapter

Multiple choice, Convenient Usage



Model	BA-1	BA-2	BA-3	BA-4	BA-5	BA-6
Suitable	Bosch	Makita	Panasonic	Milwaukee	Dewalt	Worx
Size(mm)	120×76×32	107×76×28	129×79×32	124×79×34	124×79×31	120×76×32

MDG-1 Single Digital Manifold gauge

High pressure resistance
Reliability & Durable



Model	MDG-1
Refrigerant Type	R22, R32, R134a, R290, R404A, R407A, R407C, R410A, R427A, R434A, R442A, R600a, R1234yf, R448A, R450A, R454B
Battery	Built-in Li-ion Battery(3.7V/1500mAh)
Pressure Range	0-800 psi (55 bar)
Interface	1/4" SAE
Vacuum Range	-29.5-0 inHg
Accessories	Type-C charging cable
Packing	Tool bag/Cartron:5pcs



KLÍMA PRE TEBA.SK



KPTI.CZ

MDG-2K Digital Manifold Gauge Kits

Anti-drop Design, Accurate Detection

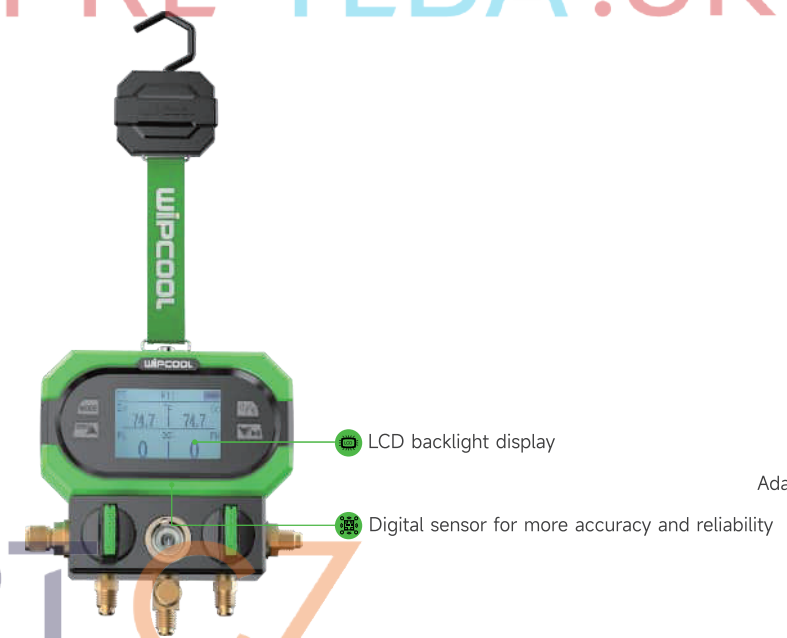

Model	MDG-2K
Refrigerant Type	R11, R12, R13, R22, R290, R32, R134a, R410A, R600a, R1234yf, R401A, R401B, R402A, R402B, R404A, R406A, R407A, R407C, R408A, R409A, R414B, R416A, R417A, R420A, R421A, R421B, R422A, R422B, R422D, R424A, R427A, R434A, R437A, R442A, R448A, R449A, R450A, R454B, R458A, R500, R502, R503, R507, R1234ZE, R744
Battery	2 X 1.5V, AAA batteries, Battery life: 200H (display with screen backlight off)
Interface	3 X 1/4" SAE
Pressure Range	-14-800 psi (55 bar)
Units	Pressure: psi, kg/cm ² , kPa, Mpa, bar, inHg Temperature: °C, °F
Accessories	Set of 3 RYB refrigeration hoses, 2 X Adapters(5/16"-1/4")
Packing	Tool bag/Cartron:5pcs

MG-1 Single Manifold Gauge

(Suit for R22,R410A,R32)

Led Lighting, Shockproof



LED lighting

Oil filled gauge

Type C charging port

Sight glass

MG-2K Manifold Gauge Kits

(Suit for R22,R410A,R32)

Led Lighting, Shockproof

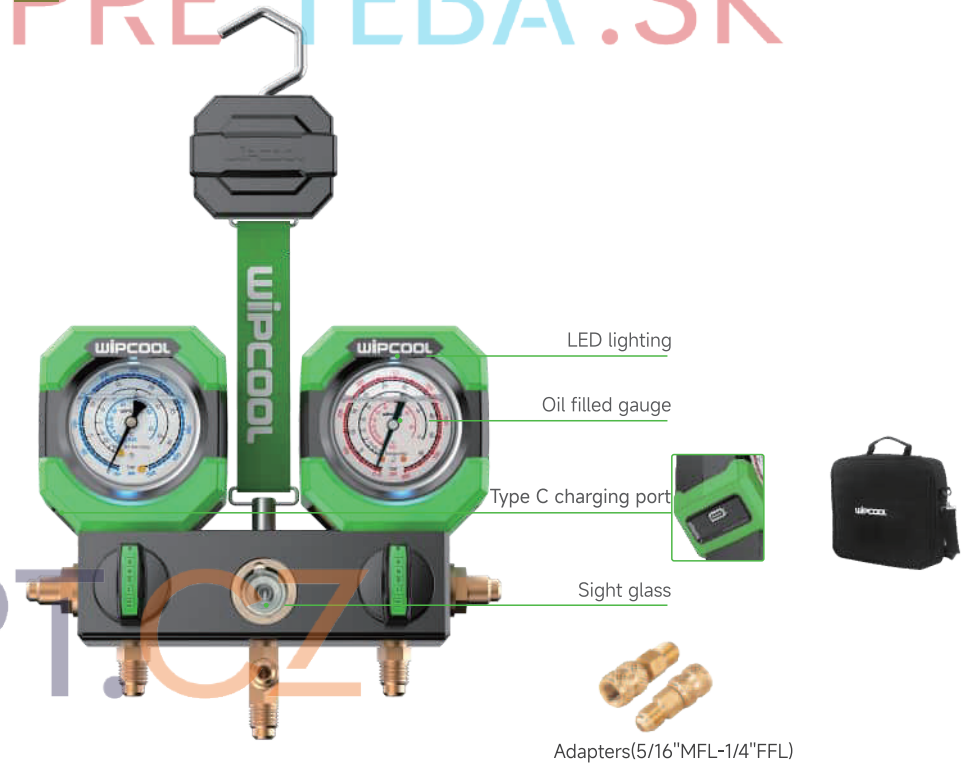

LED lighting

Oil filled gauge

Type C charging port

Sight glass

Adapters(5/16" MFL-1/4" FFL)

Model	MG-1L	MG-1H
Battery	Built-in Li-ion battery(3.7V 120mAh)	Built-in Li-ion battery(3.7V 120mAh)
Gauge Scale	R22 R410A R32	R22 R410A R32
Interface	2 X 1/4" SAE	2 X 1/4" SAE
Diameter	Ø50	Ø50
Pressure	-30inHg-500psi	-30inHg-800psi
Accessories	-	-
Packing	Blister/Cartron:24pcs	

Model	MG-2K
Battery	Built-in Li-ion battery (3.7V/120mAh)
Gauge Scale	R22 R410A R32
Interface	3 X 1/4" SAE
Diameter	Ø50
Pressure	-30inHg-500psi / -30inHg-800psi
Accessories	Set of 3 RYB refrigeration hoses, 2 X Adapters(5/16"-1/4")
Packing	Tool bag/Cartron: 6pcs

MG68-2 Manifold Gauge Kits

(Suit for R22,R32/R410a,R404A,R407C)

Integrated design, Shockproof



MG68-3K Manifold Gauge Kits

(Suit for R290,R410A/R32,R600a)

Led Lighting, Shockproof



KLÍMA PRE TEBA.SK



Shockproof

Ball Valve

Sight glass

A calibration hole at the back



LED lighting

Oil filled gauge

Type C charging port

Sight glass



A calibration hole at the back



Adapters(5/16" MFL-1/4" FFL)



Model	MG68-2	MG68-2K
Gauge Scale	R22,R410A/R32,R404A,R407C	R22,R410A/R32, R404A,R407C
Interface	3 X 1/4" SAE	3 X 1/4" SAE
Diameter	Φ60(w/o oil & led)	Φ60(w/o oil & led)
Pressure	-30inHg-500psi,-30inHg-800psi	-30inHg-500psi,-30inHg-800psi
Accessories	-	Set of 3 RYB refrigeration hoses
Packing	Blister/Cartron:10pcs	Tool bag/Cartron:6pcs

Model	MG68-3K
Battery	Built-in Li-ion battery (3.7V/120mAh)
Gauge Scale	R290,R32/R410A,R600a
Interface	3 X 1/4" SAE
Diameter	Φ60
Pressure	-30inHg-500psi,-30inHg-800psi
Accessories	Set of 3 RYB refrigeration hoses, 2 X Adapters(5/16"-1/4")
Packing	Tool Bag/Cartron:6pcs

MVG-1 Digital Vacuum Gauge



Large Display, High Accuracy

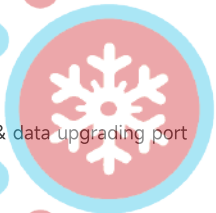
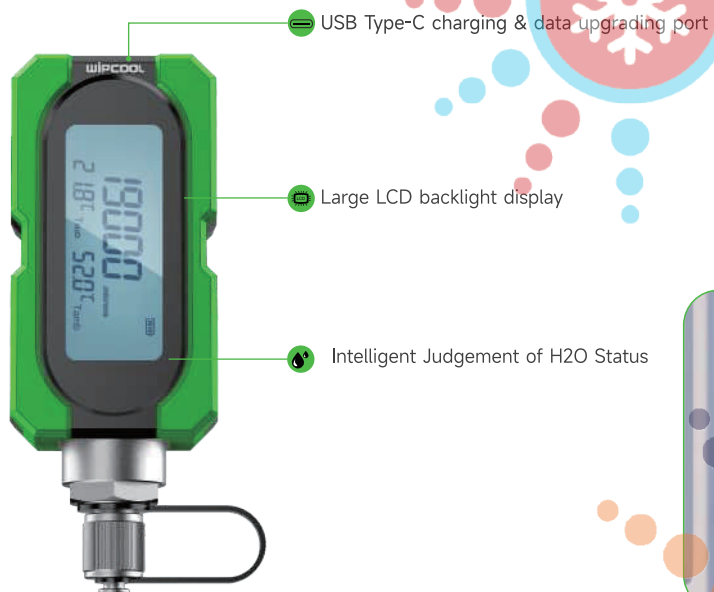

KLÍMA

MVR-1 Valve Core Removal Tools



Take Control with Faster Flow

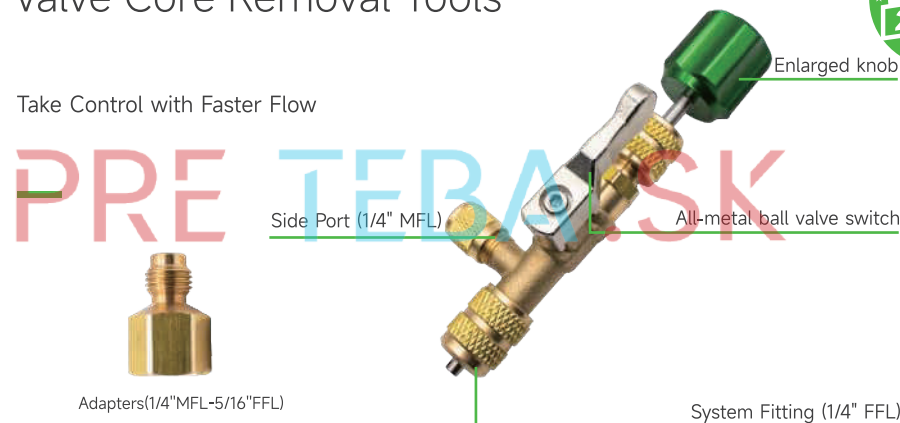

Model	MVR-1
Service ports	1/4" and 5/16" SAE
Bypass ports	1/4" SAE

MCV-1/2/3 Safety Control Valve

High pressure & Corrosion-resistant
Safety Operation

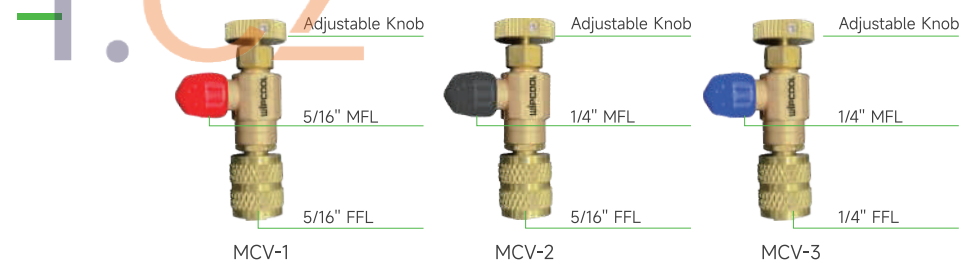

Model	MCV-1	MCV-2	MCV-3
Fittings	5/16" FFL x 5/16" MFL	5/16" FFL x 1/4" MFL	1/4" FFL x 1/4" MFL
Packing	Carton: 100pcs		

Model	MVG-1
Measuring Range	0-19000 microns
Operating Temperature	-4°F~140°F(-20°C~60°C)
Interface	1/4" SAE
Accuracy	1-10,000 microns: ±10% of readings ±10 microns 10,000-19,000 microns: ±20% of readings
Resolution	1-400microns 1 micron 400-3000microns 10 microns 3000-10000microns 100 microns 10000-19000microns 250 microns
Vacuum Units	microns, mTorr, in/hg, Pa, Torr, KPa, mbar and psia
Battery	Rechargeable lithium battery (1,000mAh)
Overload	27.5 bar
Packing	Carton:20pcs

KPT.CZ

General Refrigerant Hose Set



Model	MRH-1	MRH-2
Color	Set of 3	
Length	150cm(60")	
Working Pressure	55bar(800psi)	
Burst Pressure(Max.)	275bar(4000psi)	
Fittings	1/4"-1/4"(Y) 1/4"-5/16"(R) 1/4"-5/16"(B)	1/4"-1/4"(Y) 1/4"-1/4"(R) 1/4"-1/4"(B)
Packing	Blister/Cartron:12pcs	

Safety Valves Refrigerant Hose Set

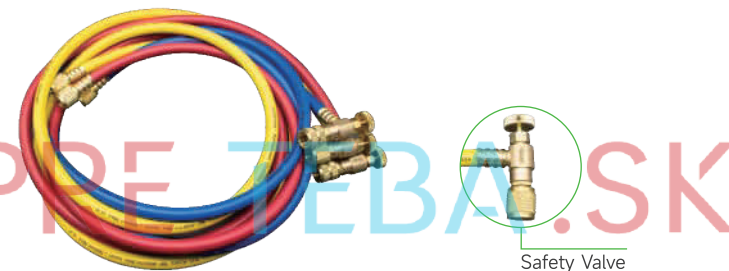

Model	MRH-1SV	MRH-2SV
Color	Set of 3	
Length	180cm(72")	
Working Pressure	55bar(800psi)	
Burst Pressure(Max.)	275bar(4000psi)	
Fittings	1/4"-1/4"(Y) 1/4"-5/16"(R) 1/4"-5/16"(B)	1/4"-1/4"(Y) 1/4"-1/4"(R) 1/4"-1/4"(B)
Packing	Blister/Cartron:12pcs	

Ball Valves Refrigerant Hose Set

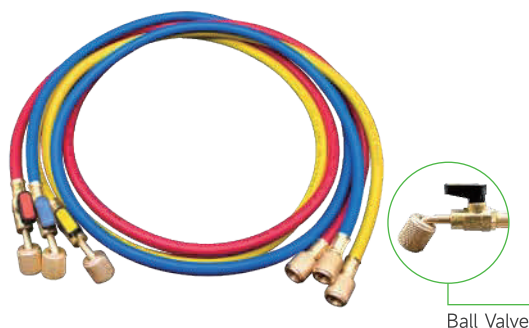

Model	MRH-1CV60°	MRH-2CV60°
Color	Set of 3	
Length	150cm(60")	
Working Pressure	55bar(800psi)	
Burst Pressure(Max.)	275bar(4000psi)	
Fittings	1/4"-1/4"(Y) 1/4"-5/16"(R) 1/4"-5/16"(B)	1/4"-1/4"(Y) 1/4"-1/4"(R) 1/4"-1/4"(B)
Packing	Blister/Cartron:12pcs	

High-Speed Evacuation Hose



Model	MHH-1	MHH-2
Color	Black	
Length	180cm(72")	
Working Pressure	34.5bar(500psi)	
Burst Pressure(Max.)	227.5bar(3300psi)	
Fittings	3/8"-3/8"	3/8"-1/4"
Packing	Carton:20pcs	



KPT.CZ

Tubing Tools

Heavy-duty Series

Copper tubing tools is a special kind of tool for the installation and maintenance of refrigeration system. So it must be reliable and durable, and the processed products must be accurate to avoid repeated invalid operations.

In WIPCOOL, We carry multiple arrays of tubing tools, including lightweight 2 in 1 flaring tool, tube cutters with standard spare blade inside, tube bender & full size tube expander, titanium coated tube deburring tool, high strength pinch off locking plier and recovery puncture pliers. Will be great help for any air conditioning and refrigeration installation and repair job.

R410A Manual Flaring Tool

Lightweight
Precise Flaring

Comfortable rotating handle

Lightweight
Aluminum flaring body

Side gauge for fast
tube height set



The expansion strip is inserted into the expansion body



The copper pipe enters the hole, and the limit plate is on the copper pipe



Slide the expanding body to the corresponding hole

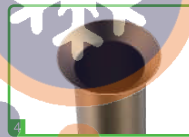

Complete expanding 45° copper pipe

Model	O.D Tube						Accessories	Packing
EF-2	1/4"	5/16"	3/8"	1/2"	5/8"	3/4"	/	Blister/Carton: 10pcs
EF-2MS	6	9	10	12	16	19mm	/	

2-in-1 Flaring Tool

Manual and Power Drive
Fast&Precise Flaring

Power tool drive

Lightweight
Aluminum flaring body

Side gauge
For fast&accurate
tube height set



EF-2LK
(Tool box with HC-32,HD-1,Hexagon drill bit)



Hexagon drill bit(6mm)



The expansion strip is inserted into the expansion body



The copper pipe enters the hole, and the limit plate is on the copper pipe

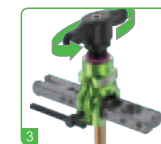

Slide the expanding body to the corresponding hole



Or use cordless drill for fast flaring



Finalize of expanding 45° copper pipe

Model	O.D Tube						Accessories	Packing
EF-2L	1/4"	5/16"	3/8"	1/2"	5/8"	3/4"	/	Blister/Carton: 9pcs
EF-2LK							HC-32,HD-1, Hexagon drill bit(6mm)	
EF-2M	1/4"	5/16"	3/8"	1/2"	5/8"	3/4"	/	Toolbox/Carton: 5pcs
EF-2MK	6	9	10	12	16	19mm	HC-32,HD-1, Hexagon drill bit(6mm)	

HC-19/32/54 Tube Cutter

Spring Mechanism
Fast & Safe Cutting

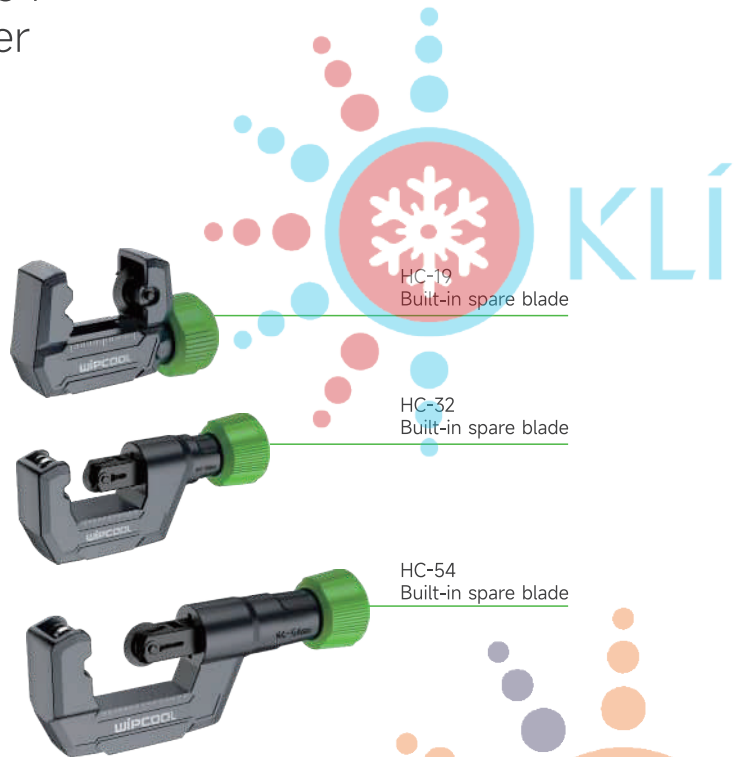

HC-19
Built-in spare blade

HC-32
Built-in spare blade

HC-54
Built-in spare blade



Spring Mechanism
(HC-32/54)



Stable grooved
rollertracking
system



An additional blade
stored in the knob



Sharp, wear-resistant
steel blades

Model	HC-19	HC-32	HC-54
Tubing O.D.	1/8" - 3/4"	3/16" - 1-1/4"	1/4" - 2-1/8"
	3-19mm	4-32mm	6-54mm
Packing	Carton: 40pcs	Carton: 20pcs	Carton: 10pcs

HB-3/HB-3M 3-in-1 Lever Tube Bender

Light & Portable

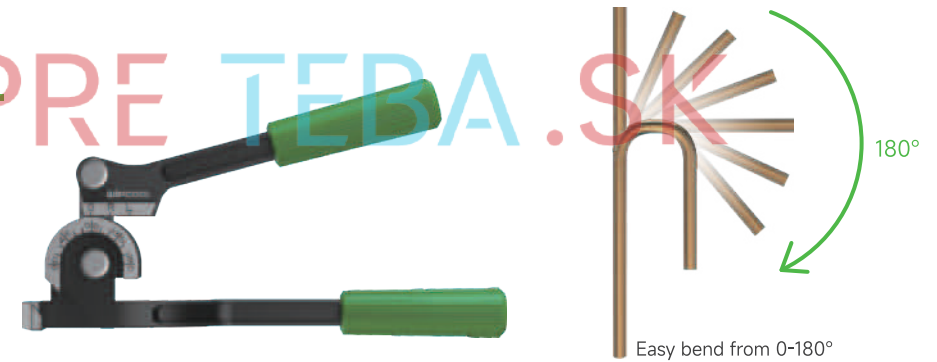

Easy bend from 0-180°

Model	HB-3	HB-3M
Tubing O.D.	1/4", 5/16", 3/8"	6, 8, 10mm
Packing	Carton: 20pcs	

HE-7/HE-11 Lever Tube Expander Kit

Lightweight & Durable.

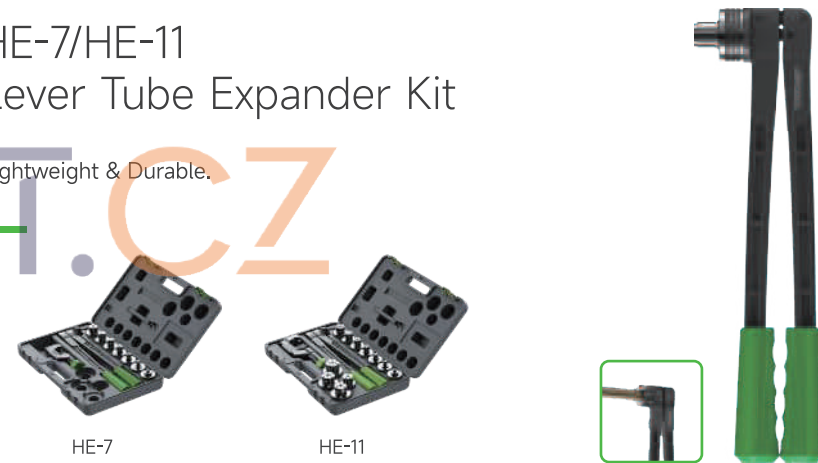

HE-7

HE-11

Model	O.D Tube	Accessories	Packing
HE-7	3/8", 1/2", 5/8", 3/4", 7/8", 1", 1-1/8"	HC-32, HD-1	Toolbox/Carton: 5pcs
HE-11	3/8", 1/2", 5/8", 3/4", 7/8", 1", 1-1/8", 1-1/4", 1-3/8", 1-1/2", 1-5/8"	HC-54, HD-1	

HD-1 HD-2 Tube Deburrer

Titanium-coated
Sharp & Durable



More smoothly deburrer

Get the spare blade by opening cover

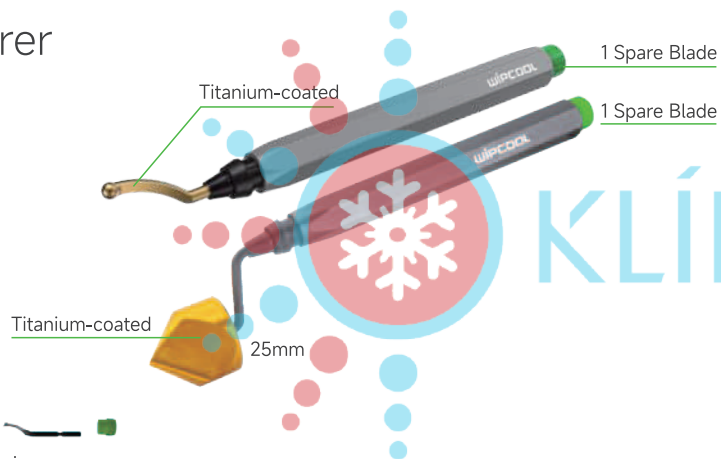

Model	HD-1	HD-2
Configuration	2 Normal Blades	1 Countersink Blade +1 Normal Blade
Packing	Blister/Carton: 50pcs	Blister/Carton: 20pcs

HW-1 HW-2 Ratchet Wrench

Flexible, Easy Using

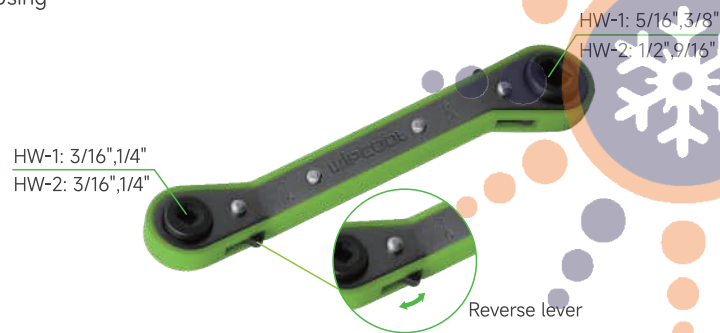

Model	HW-1	HW-2
Size	1/4", 3/8" & 3/16", 5/16"	1/4", 3/16" & 9/16", 1/2"
Packing	Blister/Carton: 50pcs	Blister/Carton: 50pcs

HL-1 Pinch Off Locking Plier

Strong Bite
Perfect Sealing



Flat bites



Hex key
adjusting screw



Fast unlock trigger



Harden stress rod

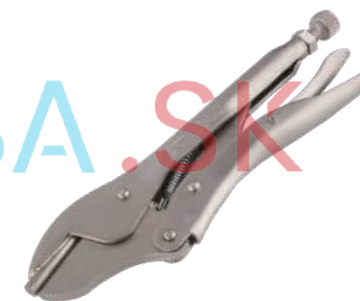

Model	Length	Width	Suitable Size	Weight	Packing
HL-1	193mm	58mm	1/8"-3/8"(3-10mm)	0.4kg	Blister/Carton: 30pcs

HP-1 Tube Piercing Plier

Sharp & Durable



Rubber pad



Hex key
adjusting screw



Tungsten needle



Hardened
connecting rod



Model	Length	Width	Suitable Size	Weight	Packing
HP-1	200mm	58mm	4-8mm	0.4kg	Blister/Carton: 30pcs

MAPP/PROPANE WELDING TORCHES

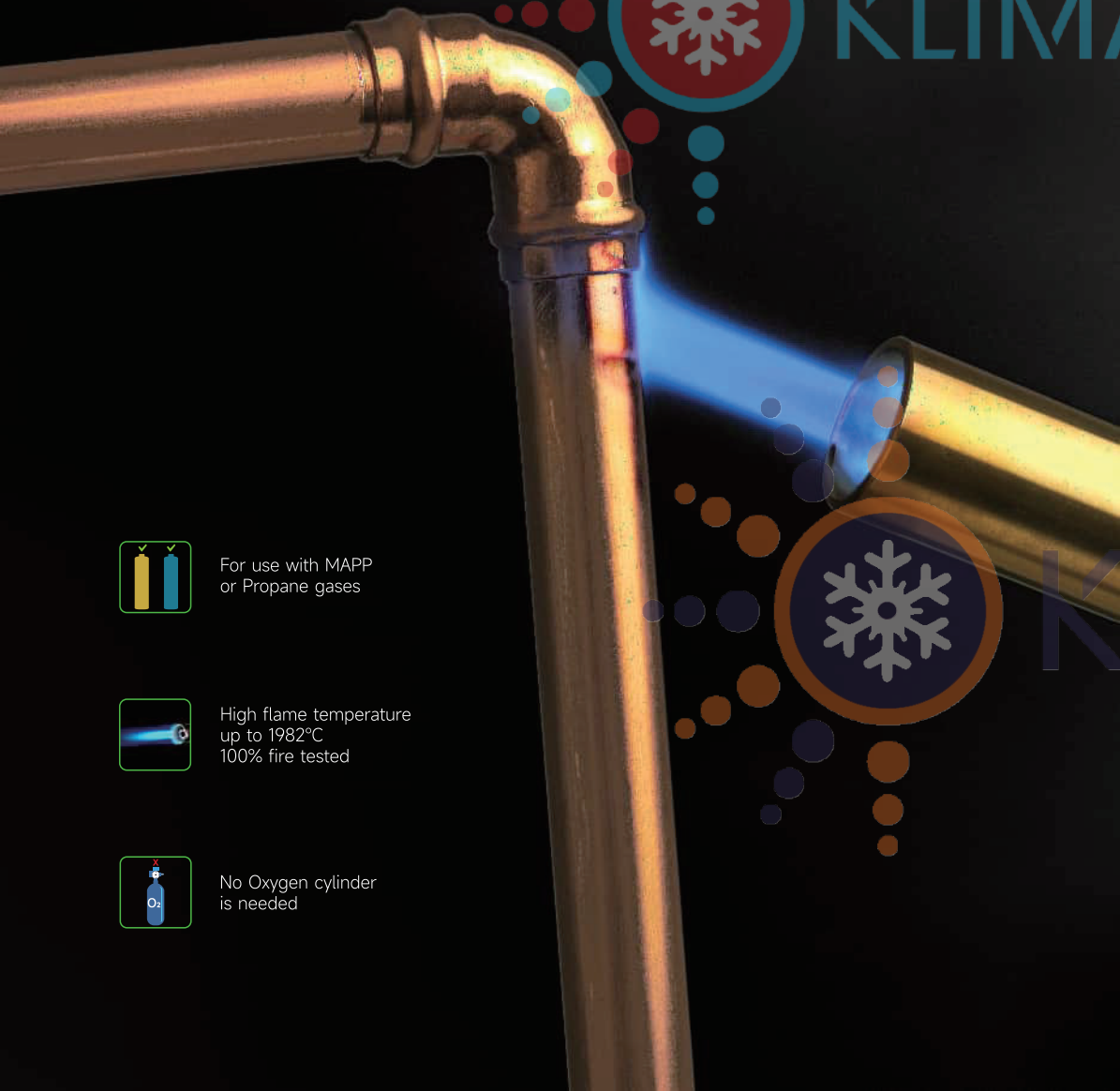

For use with MAPP
or Propane gases



High flame temperature
up to 1982°C
100% fire tested



No Oxygen cylinder
is needed

HT-1 Self-ignition Hand Torch



- Aluminum Handle
- One Handed Trigger Start
- Trigger Locks for Continuous Flame
- Dual Gas MAPP or PROPANE
- Fits All Standard MAPP & PROPANE TANKS
- Brass and Stainless Steel Construction
- Efficient Swirl Flame



45# steel thruster more
durable than brass made



Technical Data

Model:	HT-1
Gas Type	MAPP, Propane, LPG
Connection Standard	CGA600
Container	For use with 14.1-16 OZ (454g) Containers
Regulator Ratings	2.59MPa (375psi) Maximum Gas Pressure
Copper Tubing Size Capability(With Mapp Gas)	5cm/Soft Solder: Max.Φ2" 2.5cm/Brazing: Max.Φ1"
Max Flame Temperature	>1982°C/3600° F(tested with MAPP gas)
Caution	Low flame setting will result in overheat of the tip
Packing	Carton: 20pcs

HT-2 Self-ignition Torch With Hose & Auxiliary valve



- For use with MAPP or Propane Gases
- Main Regulator made of brass for safety and reliability
- Dual adjustment switching for safety and convenience



6-blade thruster

50% improved compared to 4-blade thruster



Technical Data

Model:	HT-2
Gas Type	MAPP, Propane, LPG
Connection Standard	CGA600
Container	For use with 14.1-16 OZ Containers
Regulator Ratings	2.59MPa (375psi) Maximum Gas Pressure
Copper Tubing Size Capability(With Mapp Gas)	5cm/Soft Solder: Max.Φ2" 2.5cm/Brazing: Max.Φ1"
Max Flame Temperature	>1982°C/3600° F(tested with MAPP gas)
Caution	Low flame setting will result in overheat of the tip
Packing	Carton: 25pcs

HT-3 Hand-held Self-ignition Torch



- Self-Ignition with Aluminum Housing
- Burn Tip Swivels 360°
- High Efficient Turbo Swivel Flame
- Dual gas MAPP or PROPANE
- Fits all STANDARD MAPP or PROPANE TANKS
- 100% Fire Test



Technical Data

Model:	HT-3
Gas Type	MAPP, Propane, LPG
Connection Standard	CGA600
Container	For use with 14.1-16 OZ Containers
Regulator Ratings	2.59MPa (375psi) Maximum Gas Pressure
Copper Tubing Size Capability(With Mapp Gas)	5cm/Soft Solder: Max.Φ2" 2.5cm/Brazing: Max.Φ1"
Max Flame Temperature	>1982°C/3600° F(tested with MAPP gas)
Caution	Low flame setting will result in overheat of the tip
Packing	Carton: 25pcs



KLÍMA PRE TEBA.SK

HVAC/R Testing & Measuring Equipment

Advanced Series

Testing, adjusting and balancing (TAB) are the three major steps used to achieve proper operation of heating, ventilation, air conditioning (HVAC) and refrigeration (HVACR) systems.

Professional and Reliable HVAC/R testing and measuring equipments that allows for effortless and precise measurement needed for comprehensive and professional evaluation and correct regulation of a refrigeration or air conditioning system.

In WIPCOOL ,We carry multiple arrays of electrical testing equipment, including digital anemometer, digital clamp meter, infrared thermotdetector, digital multimeter and more for any air conditioning and refrigeration installation and repair job.



KPT.CZ

ALD-1 Infrared Refrigerant Leak Detector

ALD-2 Heated Diode Refrigerant Leak Detector

Flexible probe

UV LED

High precision & sensitivity sensor

Color LCD display

Alarm Buzzer



Flexible probe

LCD display

High precision & sensitivity sensor



Model	ALD-1
Sensor Type:	Infrared sensor
Minimum Detectable Leakage:	≤4 g/year
Response Time:	≤1 seconds
Preheating Time:	30 seconds
Alarm Mode:	Audible and visual alarm; TFT indication
Operating Temperature Range:	-10-52°C
Operating Humidity Range:	<90%RH(non-condensing)
Applicable Refrigerant:	CFCs, HFCs, HCFC Blends and HFO-1234YF
Sensor Lifetime:	≤10 years
Dimensions:	201x72x 35mm (7.9"x 2.8"x 1.4")
Weight:	450g
Battery:	2x 18650 rechargeable lithium battery, full charge for 8 hours continuous work
Packing	Carton: 6pcs

Model	ALD-2
Sensor Type:	Heated diode gas sensor
Minimum Detectable Leakage:	≤3 g/year
Reaction Time:	≤3 seconds
Warm-up Time:	30 seconds
Reset Time:	≤10 seconds
Operating Temperature Range:	0-50°C
Operating Humidity Range:	<80%RH(non-condensing)
Applicable Refrigerant:	CFCs, HCFCs, HFCs, HCs and HFOs
Sensor Lifetime:	≥1 year
Reset:	Automatic / Manual
Probe Length:	420mm(16.5in)
Battery:	3 X AA alkaline battery, 7 hours continuous working
Packing	Carton: 10pcs

ASM130 Sound Level Meter



- LCD backlight
- Portable
- Fast & slow response
- High precision sound sensor

Model	ASM130
Noise (A weighted)	30-130dB
Accuracy	±1.5dB
Resolution	0.1dB
Sampling rate	Fast: 125ms; Slow: 1000ms
Frequency range	31.5Hz-8kHz
Battery	1.5V battery (R03) x 3
Packing	Carton: 40pcs

ADA30 Digital Anemometer



- LCD backlight
- Fast response
- High precision wind speed sensor
- Portable
- High precision temperature sensor

Model	ADA30	
Function	Range	Accuracy
Wind Speed Measurement	0-30m/s (Standard)	±(5%rdg+0.5)
	1.4-108Km/h (Reference)	±(5%rdg+15dgts)
	0.7-58Knots (Reference)	±(5%rdg+10dgts)
	0.8-67mph (Reference)	±(5%rdg+10dgts)
	78-5905ft/min (Reference)	±(5%rdg+180dgts)
Temperature Measurement	-10°C-50°C	±2°C
Packing	Carton: 40pcs	

ADM750 Digital Multimeter



- 2m drop test
- Data hold
- NCV detection
- LCD backlight
- hFE measurement
- Temperature measurement

Model	ADM750
DC (V)	1000V
AC (V)	750V
DC(A)	10A
AC(A)	10A
Resistance (Q)	40MΩ
Capacitance (F)	10mF
Packing	Carton: 30pcs

ADC400 Digital Clamp Meter



- Fast capacitance measurement
- Large LCD display
- AC voltage frequency measurement
- Full-featured false detection protection
- True RMS measurement
- Audio visual alarm for NCV function
- Overcurrent indication

Model	ADC400
AC current (A)	400A
AC current frequency (Hz)	50Hz-100HZ
DC voltage (V)	600V
AC voltage (V)	600V
AC voltage frequency (Hz)	10Hz-10KHz
Resistance (Q)	40MΩ
Capacitance(F)	4mF
Temperature measurement (C/°F)	-40-1000°C/-40-1832°F
Packing	Carton: 40pcs

ALM40 Laser Distance Meter



Power on/Turn on laser measure key

Return/shutdown

Area/Volume/Pythagorean measurement/Measurement datum

- Area measurement
- Single measurement
- Volume measurement
- Double Pythagorean measurement
- Multiple measurements
- One Pythagorean measurement

Model	ALM40
Accuracy of measurement unit	±5mm*
Measuring range (no reflector)	0.03-20m/30m/40m
Measuring time	0.3-4 seconds
Laser type	620-670nm, <1mw
Self-closing laser	15 seconds
Automatic shutdown	45 seconds
Display lighting	White LED
Battery type and life	2*1.5V AAA Alkaline batteries, Single measurement about 5000 times
Product size	90*40*24mm
Packing	Carton:50pcs

AWD12 Wall Detector



Tri-color indicator

LCD display

Power switch

Metal/AC switch

Wooden strip switch

Model	AWD12
Ferrous metal	120mm
Non-ferrous metal (copper)	100mm
Alternating current (ac)	50mm
Copper wire (≥4 mm 2)	40mm
Foreign body (Generally refers to the wooden block)	exact mode 20mm, deep mode 38mm
Working humidity range	-10°C - 50°C
Operating temperature range	-20°C - 70°C
Battery:	1X9 volt dry battery
The usage time	about 6 hours
Body size	147*68*27mm
Packing	Carton:50pcs

AIT500 Infrared Thermodetector



Large color LCD display

Laser button

- HVAC equipment temperature
- Food surface temperature
- Drying oven temperature

Model	AIT500
Measurement range	-50°C-500°C (-58°F-932°F)
Accuracy	-50°C-0°C:(2.2°C+0.1°C/c)0°C-500°C:±2°C or ±2%(whichever is greater)
Distance to spot ratio (D:S)	12: 1
Response time	≤250ms(95% of reading)
Emissivity	0.1-1.0(adjustable,0.95 by default)
Operating temperature	0°C-50°C (32°F-122°F)
Packing	Blister/Carton: 20pcs



SME VÁM K DISPOZÍCI

V minulosti sme sa dlhé roky zaoberali montážou klimatizácií a tepelných čerpadiel v našej materskej firme Airfitting s.r.o. a tak presne vieme čo profesionálny klimatizéri, chladiari, ale aj ich klienti potrebujú. Sú to spoľahlivé zariadenia s nadštandardnou výbavou funkcií, kvalitný montážny materiál a praktické náradie vďaka ktorému bude ich práca rýchlejšie a kvalitnejšie vykonaná.

Pamätáme ešte na doby, keď klimatizácia bola len výsada bohatých. Technológie však veľmi rýchlo napredujú a tak je klimatizácia dnes dostupná tak, ako ešte nikdy pred tým!

Klimatizácie AUX ponúkajú jedinečný dizajn, ktorý neprehliadne nikto, kto vstúpi do miestnosti. Sú tiché, pekné a spoľahlivé!

Letné horúčavy sú stále neznesiteľnejšie a my, aby sme sa cítili príjemne či už doma, alebo v kancelárii, kaviarni či v obchodnom centre, tak potrebujeme príjemné klimatizované prostredie. Dobrá klimatizácia Vaše priestory nielen dokonale vychladí na požadovanú teplotu, ale v chladnejšom období aj veľmi lacno a rýchlo vykúri. Stačí si nastaviť režim, ktorý preferujete a naše moderné technológie sa už o všetko postarajú.

Ovládanie cez, telefón, tablet či počítač Vám umožňujú nastaviť si tú správnu teplotu na diaľku, ešte pred príchodom domov.

Ponúkame odborné poradenstvo pri výbere vhodného produktu či náradia nielen starým majstrom, ale aj začínajúcim chladiarom. U nás si nakúpite kompletnú chladiarenskú výbavu, aby Vám práca robila radosť.

Sme autorizovaný predajca kvalitného montážneho náradia VALUE. Máme skladom najširšiu ponuku produktov VALUE v Česko-slovensku a ponúkame široký sortiment montážneho materiálu a náradia svetových výrobcov.

Servisná podpora a originálne náhradné diely sú u nás tiež samozrejmosťou.



NOVÝ ROZMER KVALITY



Autorizovaný distribútor klimatizácií AUX pre SR a ČR.

www.klimapreteba.sk
www.kpt.cz

Klimatizačné jednotky obsahujú fluórovú kvapalinu R32. Špecifikácie, vzhľad a funkcie sa môžu zmeniť bez predchádzajúceho upozornenia.



Veľkoobchod s klimatizáciami, montážnym materiálom a náradím pre klimatizérov a chladiarov.

Klíma pre Teba s.r.o.
Hurbanová 11
921 01 Piešťany

Osobný odber:
Hurbanová 11, 921 01 Piešťany
Sídli. SNP 41, 924 01 Galanta

Kontakty:
+421 907 04 40 80
+421 915 25 35 45
klima@klimapreteba.sk

IČO: 53 524 039
IČ DPH: SK2121392691

IBAN pre SR: SK39 8330 0000 0022 0236 7125
IBAN pre ČR: CZ65 2010 0000 0021 0265 6667